

**Test Bank for Intermediate Algebra 4th edition Sullivan and Struve
0134555805 9780134555805**

Full link download

Solution Manual

<https://testbankpack.com/p/solution-manual-for-intermediate-algebra-4th-edition-sullivan-and-struve-0134555805-9780134555805/>

Test Bank

<https://testbankpack.com/p/test-bank-for-intermediate-algebra-4th-edition-sullivan-and-struve-0134555805-9780134555805/>

MULTIPLE CHOICE. Choose the one alternative that best completes the statement or answers the question.

1)

Answer: No Correct Answer Was Provided.

Provide an appropriate response.

2) If a relation exists between x and y , then we say that x _____ y or that y _____ x , and we write $x \rightarrow y$.

A) depends on; corresponds to

B) corresponds to; corresponds to

C) corresponds to; depends on

D) depends on; depends on

Answer: C

3) Use the map to represent the relation as a set of ordered pairs.

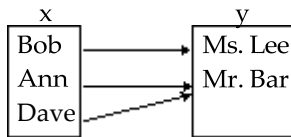

A) $\{(Bob, Mr. Bar), (Ann, Ms. Lee), (Dave, Ms. Lee)\}$

B) $\{(Mr. Bar, Bob), (Ms. Lee, Ann), (Ms. Lee, Dave)\}$

C) $\{(Ms. Lee, Bob), (Mr. Bar, Ann), (Mr. Bar, Dave)\}$

D) $\{(Bob, Ms. Lee), (Ann, Mr. Bar), (Dave, Mr. Bar)\}$

Answer: D

SHORT ANSWER. Write the word or phrase that best completes each statement or answers the question.

4) Use the set of ordered pairs to represent the relation as a map.

$\{(5, 15), (8, 24), (11, 33), (14, 42)\}$

Answer:

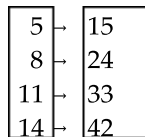

MULTIPLE CHOICE. Choose the one alternative that best completes the statement or answers the question.

Identify the domain and range of the relation.

5)

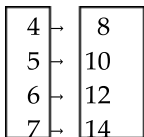

A) domain: $\{8, 10, 12, 14\}$

B) domain: $\{4, 5, 6, 7\}$

range: $\{4, 5, 6, 7\}$

range: $\{8, 10, 12, 14\}$

Answer: B

6)

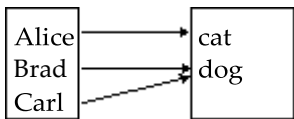

A) domain: {cat, dog}
range: {Alice, Brad, Carl}

B) domain: {Alice, Brad, Carl}
range: {cat, dog}

Answer: B

7) $\{(-2, -6), (0, 4), (4, 0), (7, -2)\}$

A) domain: $\{-2, 0, 4, 7\}$
range: $\{-6, 4, 0, -2\}$

B) domain: $\{-6, 4, 0, -2\}$
range: $\{-2, 0, 4, 7\}$

Answer: A

8) $\{(-3, 12), (-2, 7), (0, 3), (2, 7), (4, 19)\}$

A) domain: $\{-3, -2, 0, 2, 4\}$
range: $\{12, 7, 3, 19\}$

B) domain: $\{12, 7, 3, 19\}$
range: $\{-3, -2, 0, 2, 4\}$

Answer: A

Identify the domain and the range of the relation from the graph.

9)

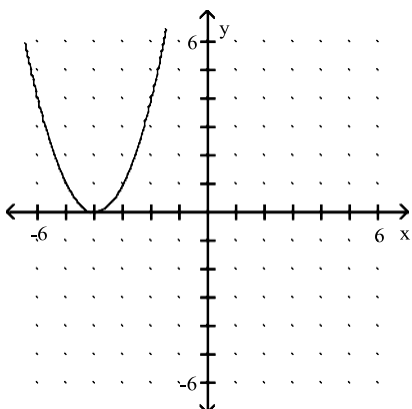

A) Domain: $(-\infty, 0)$
Range: $[-4, \infty)$

B) Domain: $(-\infty, 0)$
Range: $[0, \infty)$

C) Domain: $(-\infty, \infty)$
Range: $[0, \infty)$

D) Domain: $(-\infty, \infty)$
Range: $(-\infty, \infty)$

Answer: C

10)

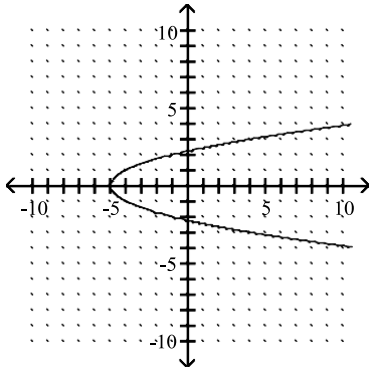

A) Domain: $[-5, \infty)$
Range: $(-\infty, \infty)$

B) Domain: $[5, \infty)$
Range: $(-\infty, \infty)$

C) Domain: $(-\infty, \infty)$
Range: $[-5, \infty)$

D) Domain: $(-\infty, \infty)$
Range: $[5, \infty)$

Answer: A

11)

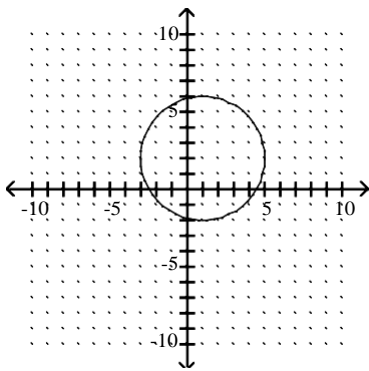

A) Domain: $[-3, \infty)$
Range: $[5, \infty)$

B) Domain: $(-\infty, 5]$
Range: $(-\infty, -2]$

C) Domain: $[-3, 5]$
Range: $[-2, 6]$

D) Domain: $[-2, 6]$
Range: $[-3, 5]$

Answer: C

12)

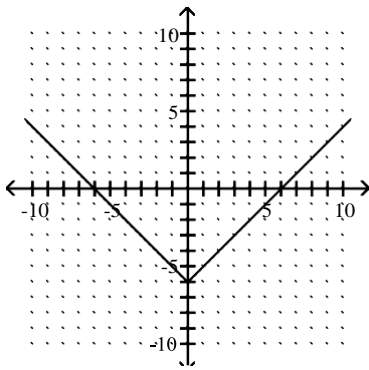

A) Domain: $[0, \infty)$
Range: $(-\infty, \infty)$

B) Domain: $(-\infty, \infty)$
Range: $(-\infty, \infty)$

C) Domain: $(-\infty, \infty)$
Range: $[-6, \infty)$

D) Domain: $[-6, \infty)$
Range: $(-\infty, \infty)$

Answer: C

Use the graph of the relation to identify the domain and range.

13) $y = 7x$

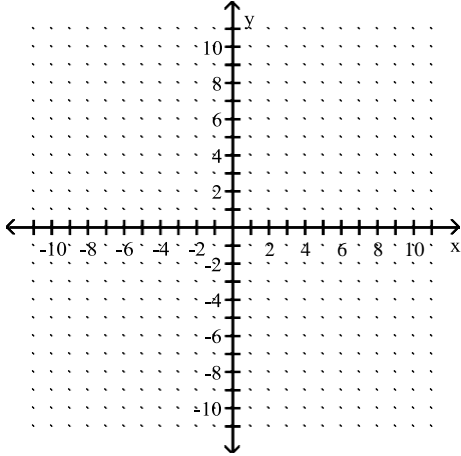

A) domain: $(7, \infty)$
range: $(-\infty, \infty)$

B) domain: $(-\infty, \infty)$
range: $(-\infty, \infty)$

C) domain: $(-\infty, \infty)$
range: $(7, \infty)$

D) domain: $(7, \infty)$
range: $(7, \infty)$

Answer: B

14) $y = -\frac{1}{9}x$

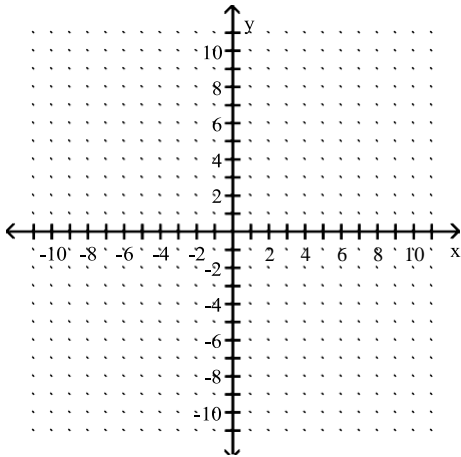

A) domain: $(-\infty, \infty)$
range: $\left(-\infty, -\frac{1}{9}\right)$

B) domain: $(-\infty, 0)$
range: $(-\infty, \infty)$

C) domain: $\left(-\frac{1}{9}, \infty\right)$
range: $(-\infty, \infty)$

D) domain: $(-\infty, \infty)$
range: $(-\infty, \infty)$

Answer: D

15) $y = x - 3$

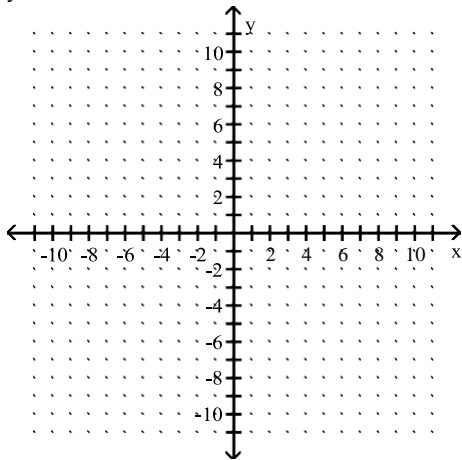

A) domain: $(-\infty, \infty)$
range: $(3, \infty)$

B) domain: $(-\infty, \infty)$
range: $(-\infty, \infty)$

C) domain: $(3, \infty)$
range: $(-\infty, \infty)$

D) domain: $(-3, \infty)$
range: $(-\infty, \infty)$

Answer: B

16) $y = -5x - 6$

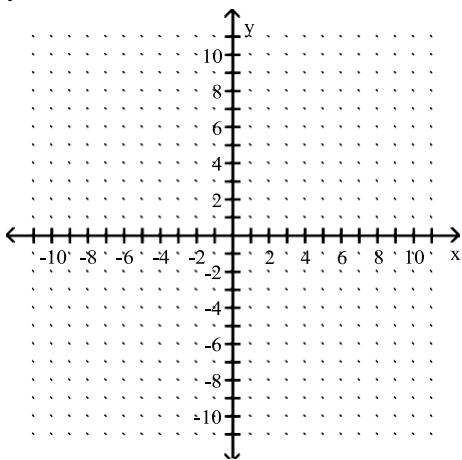

A) domain: $(6, \infty)$
range: $(-\infty, \infty)$

B) domain: $(-\infty, \infty)$
range: $(-\infty, \infty)$

C) domain: $[6, \infty)$
range: $(-\infty, \infty)$

D) domain: $(-\infty, \infty)$
range: $\left[-\frac{6}{5}, \infty\right)$

Answer: B

17) $4x + y = 1$

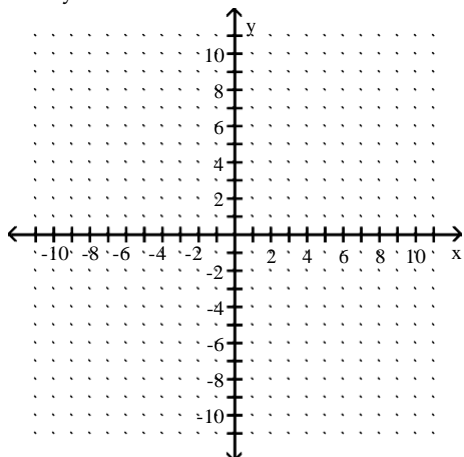

A) domain: $\left(-\frac{1}{4}, \infty\right)$
range: $(-\infty, \infty)$

B) domain: $(-\infty, \infty)$
range: $\left[-\frac{1}{4}, \infty\right)$

C) domain: $\left(\frac{1}{4}, \infty\right)$
range: $(-\infty, \infty)$

D) domain: $(-\infty, \infty)$
range: $(-\infty, \infty)$

Answer: D

18) $y = x^2 + 2$

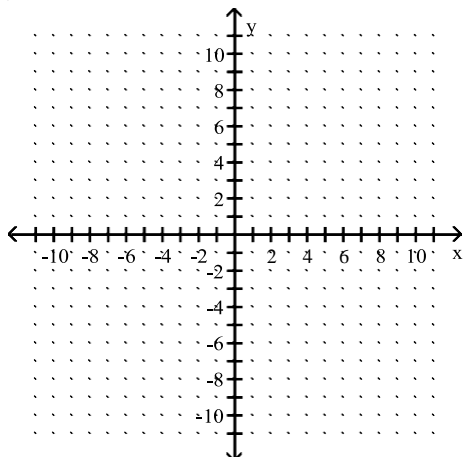

A) domain: $(-\infty, \infty)$
range: $(-\infty, \infty)$

B) domain: $(-\infty, \infty)$
range: $(2, \infty)$

C) domain: $(-\infty, \infty)$
range: $[2, \infty)$

D) domain: $(-\infty, \infty)$
range: $[-2, 2]$

Answer: C

19) $y = |x| - 6$

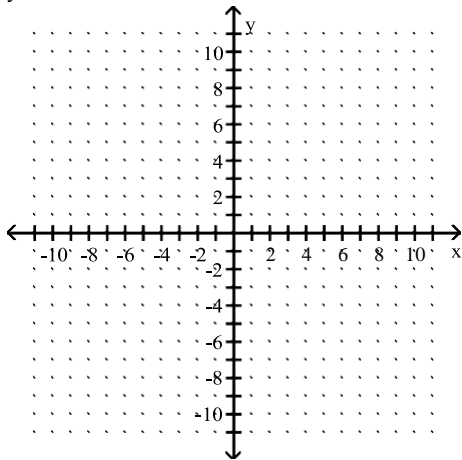

A) domain: $(-\infty, \infty)$
range: $(-6, 6)$

B) domain: $(-\infty, \infty)$
range: $[-6, \infty)$

C) domain: $(-\infty, \infty)$
range: $(-\infty, \infty)$

D) domain: $(-\infty, \infty)$
range: $(-6, \infty)$

Answer: B

20) $y = |x + 4|$

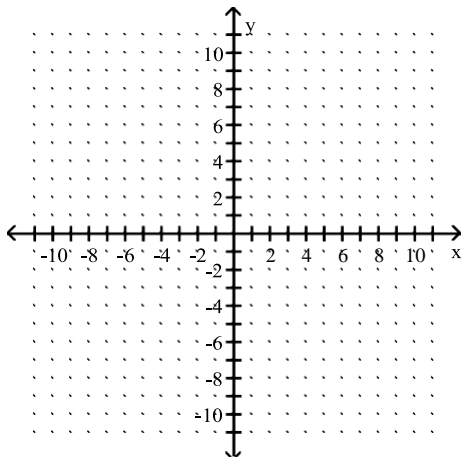

A) domain: $(-\infty, \infty)$
range: $[-4, \infty)$

B) domain: $[-4, \infty)$
range: $(-\infty, \infty)$

C) domain: $(-\infty, \infty)$
range: $(-\infty, \infty)$

D) domain: $(-\infty, \infty)$
range: $[0, \infty)$

Answer: D

21) $y = x^3 - 2$

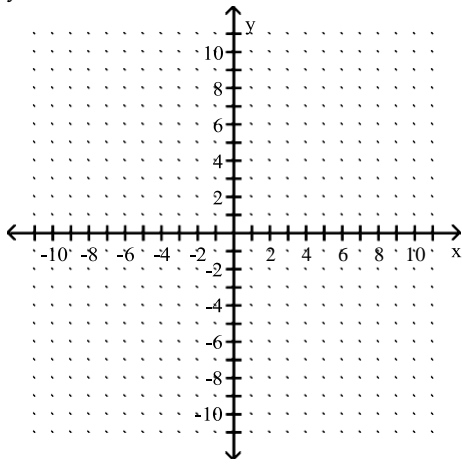

A) domain: $(-\infty, \infty)$
range: $(2, \infty)$

B) domain: $(-\infty, \infty)$
range: $(-\infty, \infty)$

C) domain: $(-2, \infty)$
range: $(-\infty, \infty)$

D) domain: $(2, \infty)$
range: $(-\infty, \infty)$

Answer: B

22) $x = y^2 - 1$

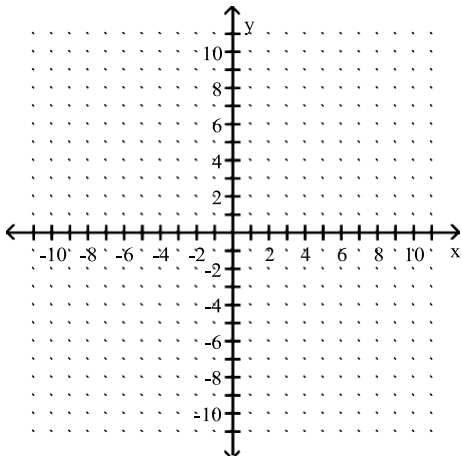

A) domain: $[-1, 1]$
range: $(-\infty, \infty)$

B) domain: $(-\infty, \infty)$
range: $(-\infty, \infty)$

C) domain: $(-\infty, \infty)$
range: $[-1, \infty)$

D) domain: $[-1, \infty)$
range: $(-\infty, \infty)$

Answer: D

Solve.

23) An arrow is fired into the air with an initial velocity of 96 feet per second. The height in feet of the arrow t seconds after it was shot into the air is given by the function $h(t) = -16t^2 + 96t$. Find the domain and the range of the relation.

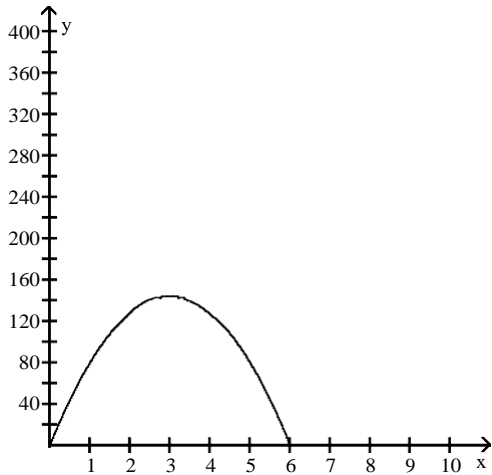

- A) Domain: [0, 96]; Range: [0, 6]
- C) Domain: [0, 6]; Range: [0, 96]

- B) Domain: [0, 6]; Range: [0, 144]
- D) Domain: [0, 6]; Range: [0, 240]

Answer: C

Determine whether the relation represents a function. If it is a function, state the domain and range.

24)

5	→	10
7	→	14
9	→	18
11	→	22

- A) function
domain: {5, 7, 9, 11}
range: {10, 14, 18, 22}

- B) function
domain: {10, 14, 18, 22}
range: {5, 7, 9, 11}

- C) not a function

Answer: A

25)

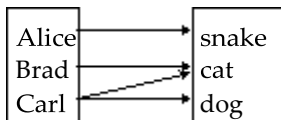

- A) function
domain: {snake, cat, dog}
range: {Alice, Brad, Carl}

- B) function
domain: {Alice, Brad, Carl}
range: {snake, cat, dog}

- C) not a function

Answer: C

26)

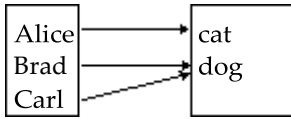

A) function
domain: {cat, dog}
range: {Alice, Brad, Carl}

Answer: B

B) function
domain: {Alice, Brad, Carl}
range: {cat, dog}

C) not a function

27) $\{(-1, 7), (1, 4), (4, -4), (6, -1)\}$

A) function
domain: {7, 4, -4, -1}
range: {-1, 1, 4, 6}

Answer: B

B) function
domain: {-1, 1, 4, 6}
range: {7, 4, -4, -1}

C) not a function

28) $\{(29, -3), (4, -2), (4, 0), (8, 2), (20, 4)\}$

A) function
domain: {-3, -2, 0, 2, 4}
range: {29, 8, 4, 20}

Answer: C

B) function
domain: {29, 8, 4, 20}
range: {-3, -2, 0, 2, 4}

C) not a function

29) $\{(-4, 19), (-3, 12), (0, 3), (3, 12), (5, 28)\}$

A) function
domain: {-4, -3, 0, 3, 5}
range: {19, 12, 3, 28}

Answer: A

B) function
domain: {19, 12, 3, 28}
range: {-4, -3, 0, 3, 5}

C) not a function

Determine whether the equation is a function.

30) $y = x^3$

A) function

Answer: A

B) not a function

31) $y^2 = 9 - x^2$

A) function

Answer: B

B) not a function

32) $x = y^2$

A) function

Answer: B

B) not a function

33) $y^2 + x = 9$

A) function

Answer: B

B) not a function

34) $y = 5x^2 - 6x + 9$

A) function

Answer: A

B) not a function

35) $x^2 + 4y^2 = 1$

A) function

Answer: B

B) not a function

36) $x - 3y = 8$

A) function

Answer: A

B) not a function

Determine whether the graph is that of a function.

37)

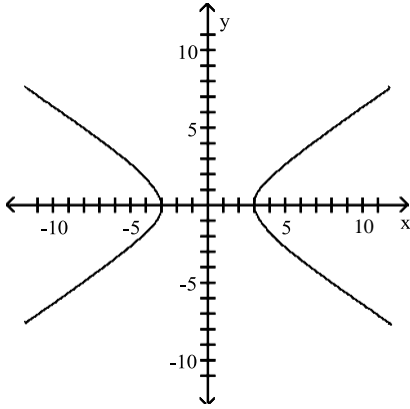

A) function

Answer: B

B) not a function

38)

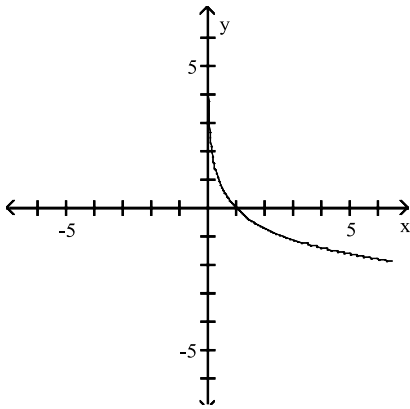

A) function

Answer: A

B) not a function

39)

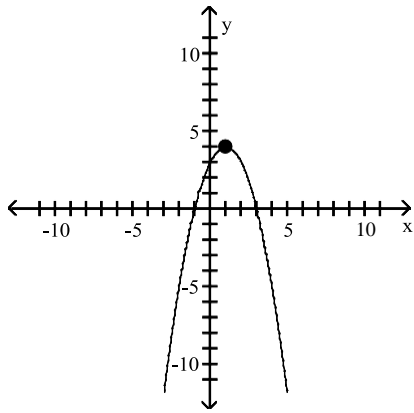

A) function

B) not a function

Answer: A

40)

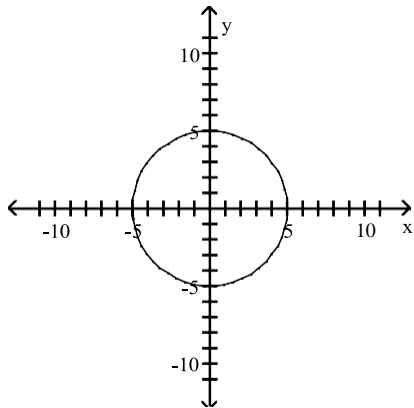

A) function

B) not a function

Answer: B

41)

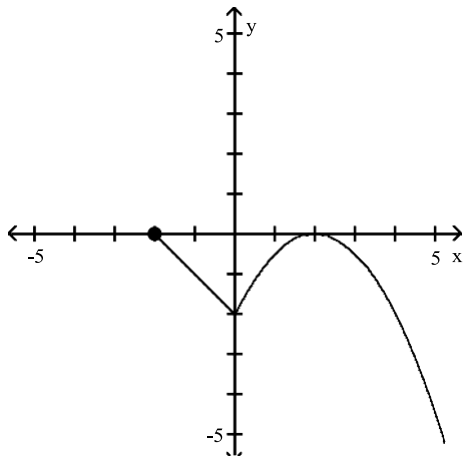

A) function

B) not a function

Answer: A

Find the function value.

42) Find $f(12)$ when $f(x) = 14x + 19$.

- A) -149 B) 149 C) 187 D) 169.9

Answer: C

43) Find $f(-4)$ when $f(x) = -5x + 3$.

- A) -17 B) -2 C) 20 D) 23

Answer: D

44) Find $f(-x)$ when $f(x) = -3x - 2$.

- A) $-3x + 2$ B) $3x + 2$ C) $-x - 2$ D) $3x - 2$

Answer: D

45) Find $-f(x)$ when $f(x) = -3x + 1$.

- A) $3x + 1$ B) $-x - 1$ C) $-3x - 1$ D) $3x - 1$

Answer: D

46) Find $f(x - 3)$ when $f(x) = 5x + 6$.

- A) $5x + 3$ B) $5x + 9$ C) $5x - 12$ D) $5x - 9$

Answer: D

47) Find $f(-4x)$ when $f(x) = 3x - 4$.

- A) $-12x - 4$ B) $12x - 4$ C) $12x + 4$ D) $-12x + 16$

Answer: A

48) Find $f(3)$ when $f(x) = x^2 + 3x - 2$.

- A) 2 B) -2 C) 16 D) 20

Answer: C

49) Find $f(0)$ when $f(x) = x^2 - 4x + 4$.

- A) 0 B) 4 C) -4 D) 16

Answer: B

50) Find $f(-6)$ when $f(x) = 7 - 3x^2$.

- A) 115 B) 43 C) 25 D) -101

Answer: D

51) Find $f(-9)$ when $f(x) = |x| - 6$.

- A) -15 B) 3 C) 15 D) -3

Answer: B

52) Find $f(x + h)$ when $f(x) = -3x^2 - 4x - 4$.

- A) $-3x^2 - 3h^2 - 10x - 10h - 4$ B) $-3x^2 - 3xh - 3h^2 - 4x - 4h - 4$
C) $-3x^2 - 3h^2 - 4x - 4h - 4$ D) $-3x^2 - 6xh - 3h^2 - 4x - 4h - 4$

Answer: D

53) $f(x) = \frac{x+8}{14x-8}; f(3)$

A) $-\frac{11}{34}$

B) $\frac{11}{104}$

C) $\frac{11}{50}$

D) $\frac{11}{34}$

Answer: D

54) $f(x) = \frac{x-7}{2x+9}; f(-5)$

A) -12

B) 1

C) -1

D) 12

Answer: D

55) $f(x) = \frac{x^2-5}{x^3-5x}; f(2)$

A) -2

B) $\frac{1}{2}$

C) $-\frac{1}{8}$

D) $-\frac{1}{3}$

Answer: B

Find the domain of the function.

56) $h(x) = 2x - 4$

A) $\{x | x > 0\}$

C) $\{x | x \geq 4\}$

B) $\{x | x \text{ is any real number}\}$

D) $\{x | x \neq 0\}$

Answer: B

57) $f(x) = \frac{2x-3}{x+6}$

A) $\left\{x | x \neq \frac{3}{2}\right\}$

B) $\{x | x \neq 6\}$

C) $\{x | x \neq -6\}$

D) $\left\{x | x \neq -6, \frac{3}{2}\right\}$

Answer: C

58) $s(t) = t^2 + 1$

A) $\{t | t \text{ is any real number}\}$

C) $\{t | t \neq -1\}$

B) $\{t | t > -1\}$

D) $\{t | t \geq -1\}$

Answer: A

59) $F(z) = \frac{z}{z^2+5}$

A) $\{z | z > -5\}$

C) $\{z | z \text{ is any real number}\}$

B) $\{z | z \neq 0\}$

D) $\{z | z \neq -5\}$

Answer: C

60) $f(x) = \frac{1}{7x+2}$

A) $\left\{x | x \neq 0, \frac{2}{7}\right\}$

B) $x | x \neq -\frac{2}{7}, 0$

C) $x | x \neq \frac{2}{7}$

D) $x | x \neq -\frac{2}{7}$

Answer: D

7

{ 7 }

{ 7 }

{ 7 }

61) $H(q) = \frac{10q - 4}{6}$

A) $\{q \mid q \neq -6\}$

C) $\{q \mid q \neq 6\}$

B) $\left\{q \mid q \neq \frac{2}{5}\right\}$

D) $\{q \mid q \text{ is any real number}\}$

Answer: D

Solve the problem.

62) If $f(x) = 4x^3 + 2x^2 - x + C$ and $f(3) = 1$, what is the value of C?

A) $C = 94$

B) $C = 130$

C) $C = -20$

D) $C = -122$

Answer: D

63) If $f(x) = \frac{x - 5A}{-5x + 5}$ and $f(-5) = 15$, what is the value of A?

A) $A = 91$

B) $A = -31$

C) $A = -91$

D) $A = 31$

Answer: C

64) The cost C, in dollars, to produce graphing calculators is given by the function $C(x) = 55x + 3500$, where x is the number of calculators produced. How many calculators can be produced if the cost is limited to \$119,000?

A) 2227 calculators

B) 1900 calculators

C) 2380 calculators

D) 2100 calculators

Answer: D

65) The cost C, in dollars, to produce graphing calculators is given by the function $C(x) = 50x + 3500$, where x is the number of calculators produced. What is the cost to produce 1000 calculators?

A) \$50,000

B) \$53,500

C) \$53,850

D) \$46,500

Answer: B

66) A projectile is fired from a cliff 500 feet above the water at an inclination of 45° to the horizontal, with a muzzle velocity of 230 feet per second. The height h of the projectile above the water is given by $h(x) = \frac{-32x^2}{(230)^2} + x + 500$,

where x is the horizontal distance of the projectile from the base of the cliff. Find the maximum height of the projectile.

A) 913.28 ft

B) 1739.84 ft

C) 413.28 ft

D) 826.56 ft

Answer: A

67) A projectile is fired from a cliff 500 feet above the water at an inclination of 45° to the horizontal, with a muzzle velocity of 270 feet per second. The height h of the projectile above the water is given by $h(x) = \frac{-32x^2}{(270)^2} + x + 500$,

where x is the horizontal distance of the projectile from the base of the cliff. How far from the base of the cliff is the height of the projectile a maximum?

A) 1069.53 ft

B) 1139.06 ft

C) 2208.59 ft

D) 569.53 ft

Answer: B

68) The volume V of a square-based pyramid with base sides s and height h is $V = \frac{1}{3}s^2h$. If the height is half of the length of a base side, express the volume V as a function of s .

A) $V(s) = \frac{1}{3}s^2$

B) $V(s) = \frac{1}{6}s^3$

C) $V(s) = \frac{1}{3}s^3h$

D) $V(s) = \frac{1}{6}s^3h$

Answer: B

Graph the function.

69) $f(x) = 3x + 4$

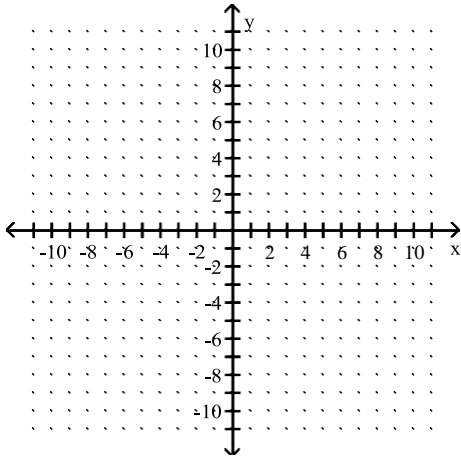

A)

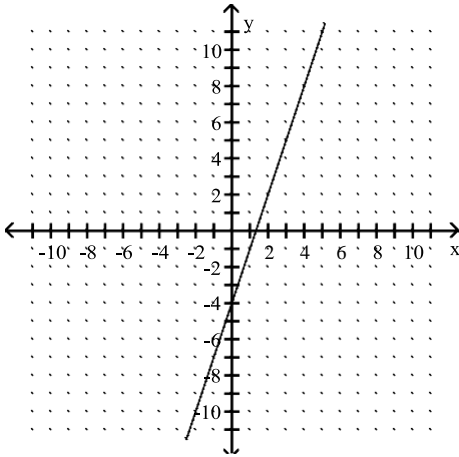

C)

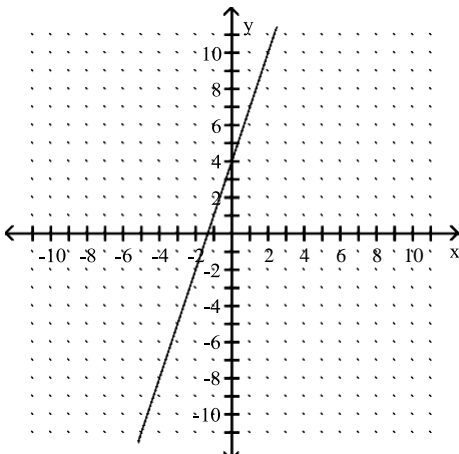

Answer: C

B)

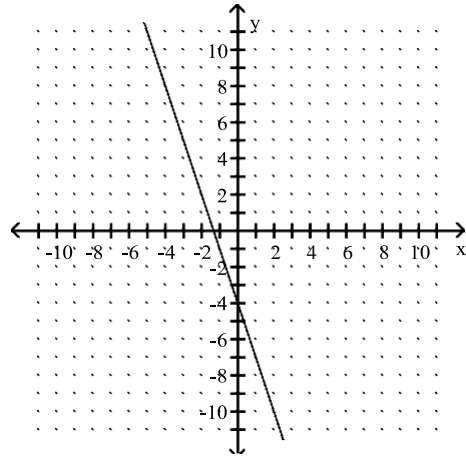

D)

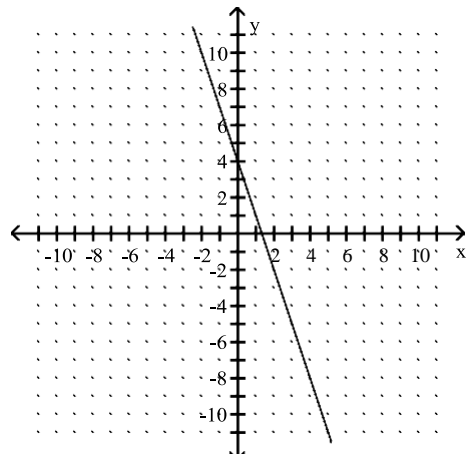

70) $f(x) = -3x + 9$

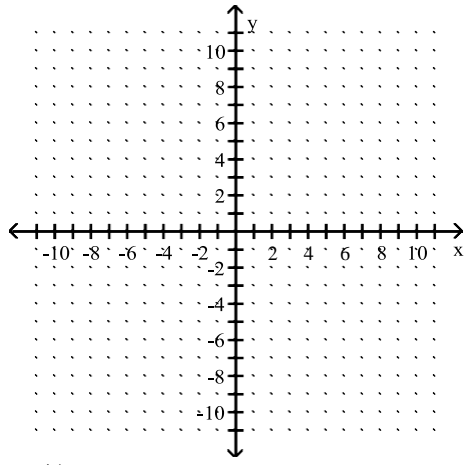

A)

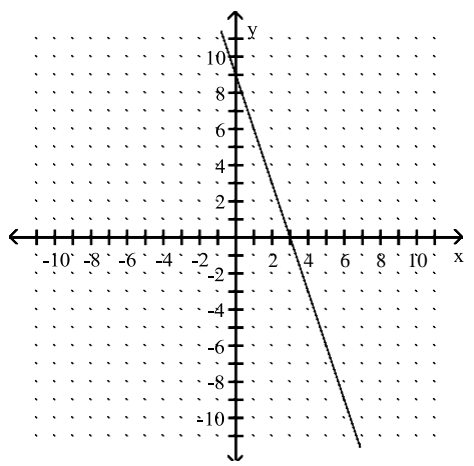

C)

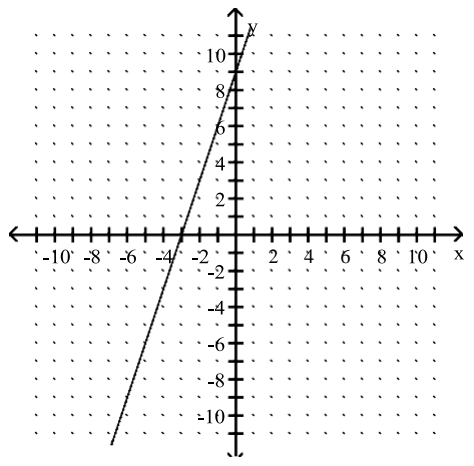

Answer: A

B)

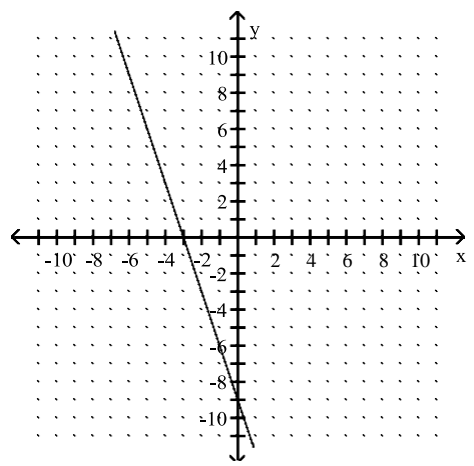

D)

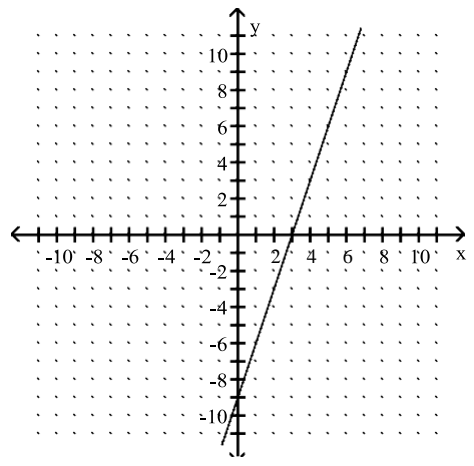

71) $g(x) = 3x - 4$

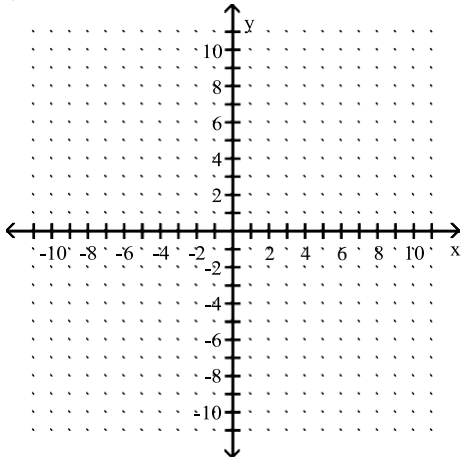

A)

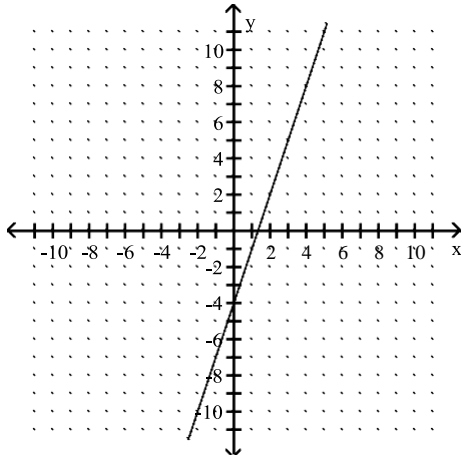

B)

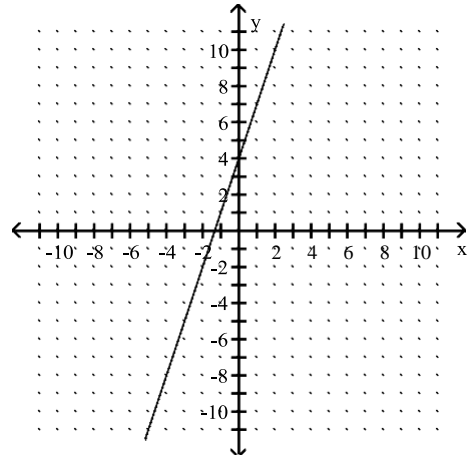

C)

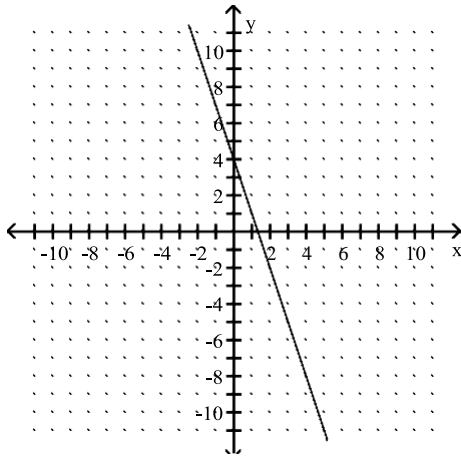

D)

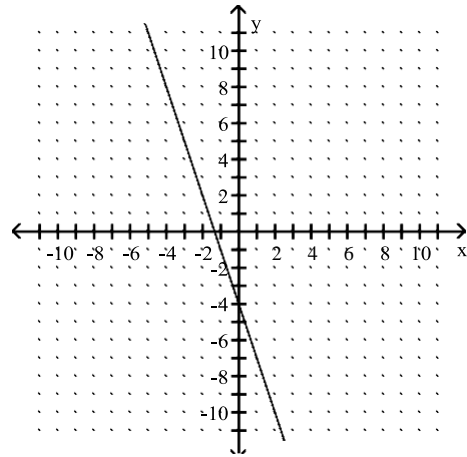

Answer: A

72) $g(x) = -4x - 8$

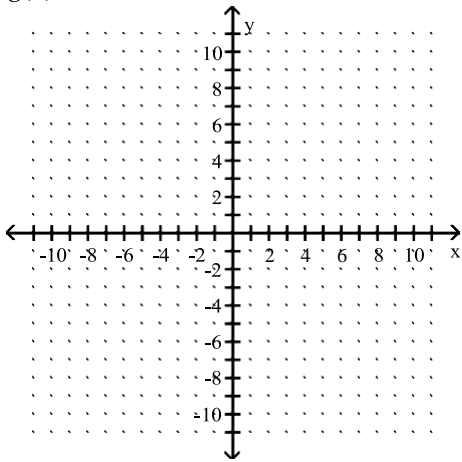

A)

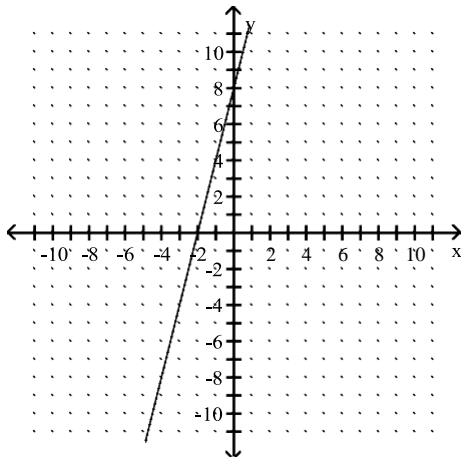

B)

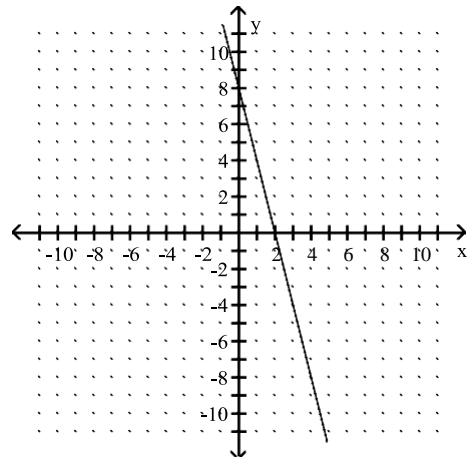

C)

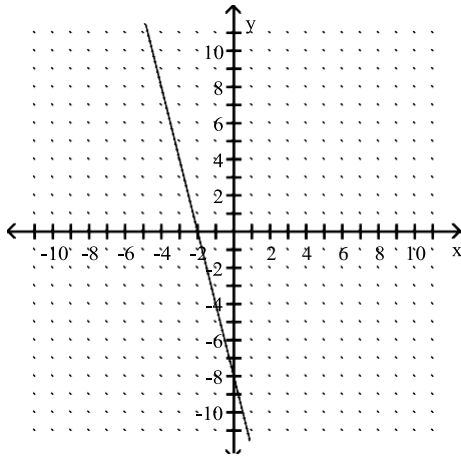

D)

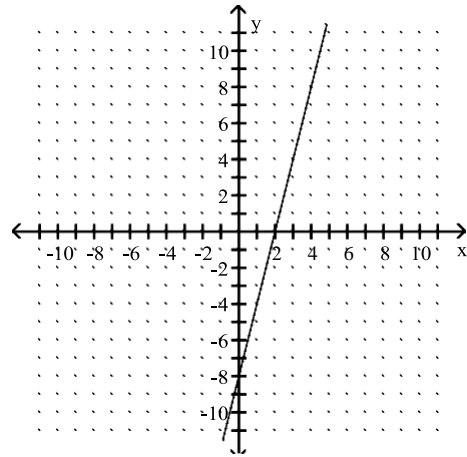

Answer: C

73) $h(x) = x^2 - 2$

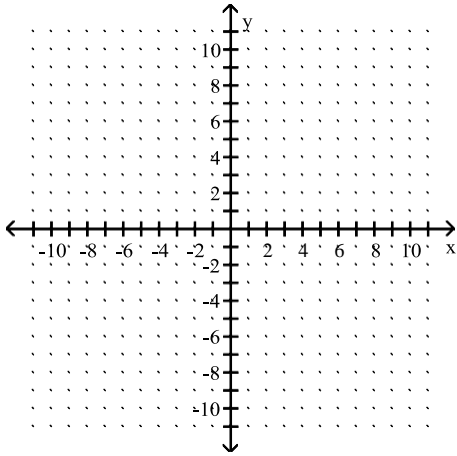

A)

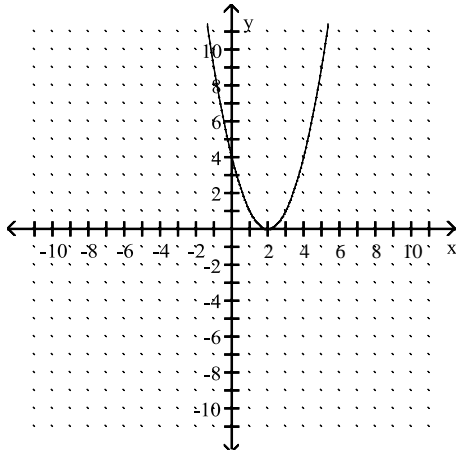

B)

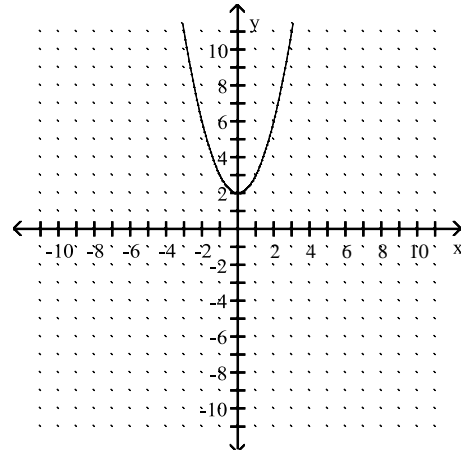

C)

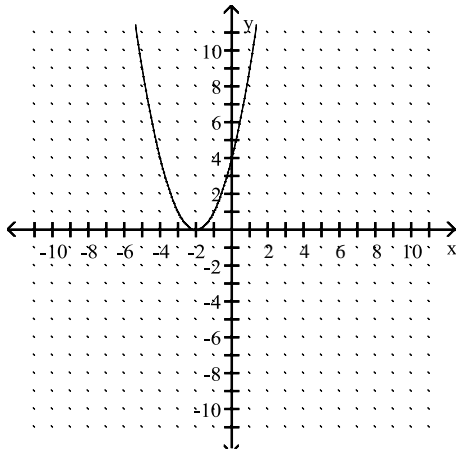

D)

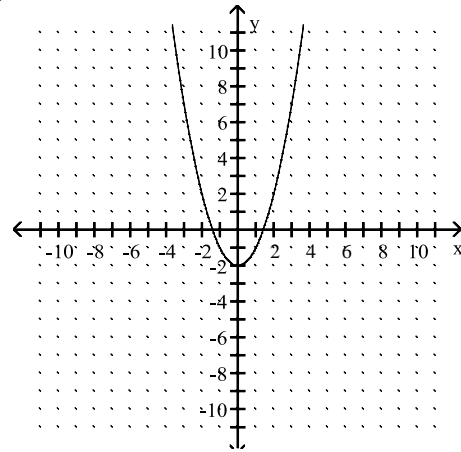

Answer: D

74) $G(x) = |x - 3|$

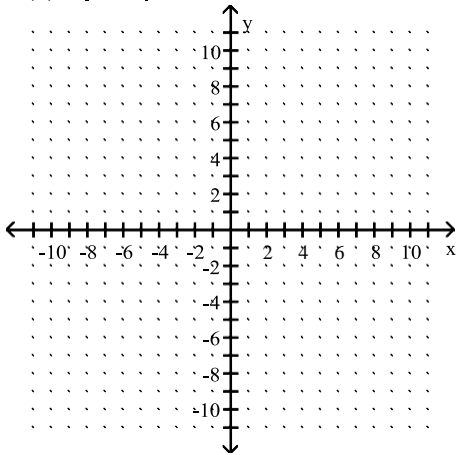

A)

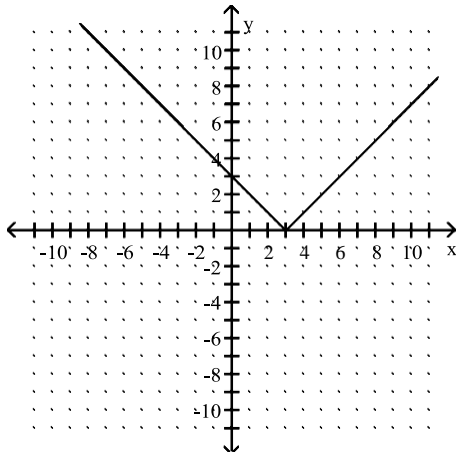

B)

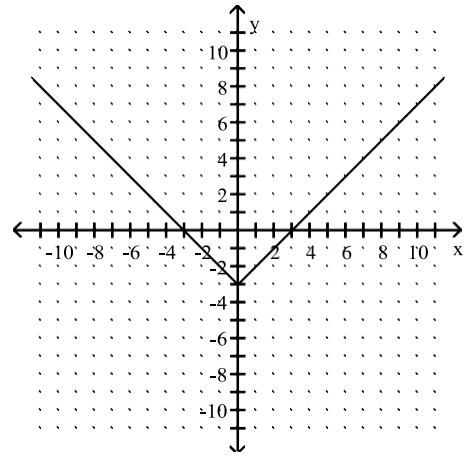

C)

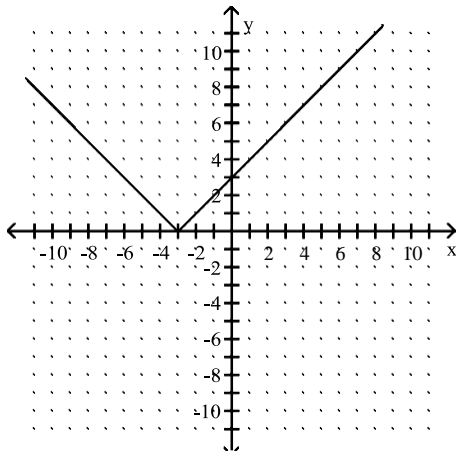

D)

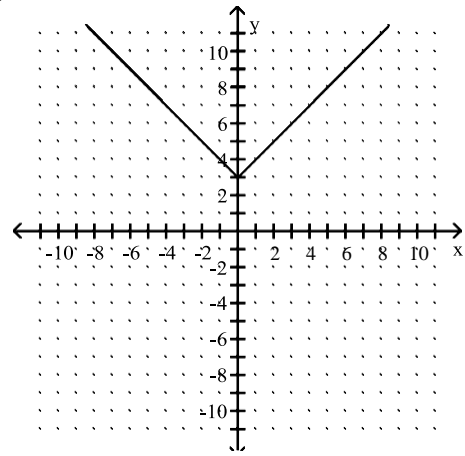

Answer: A

75) $F(x) = x^3 + 4$

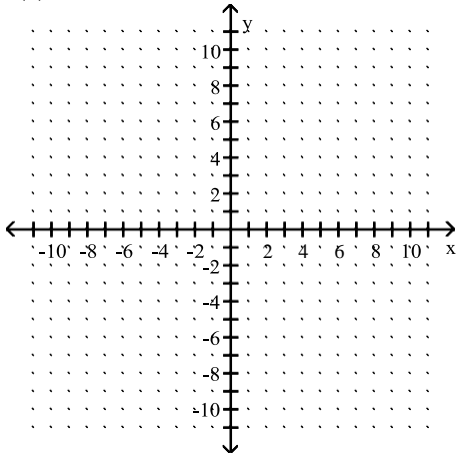

A)

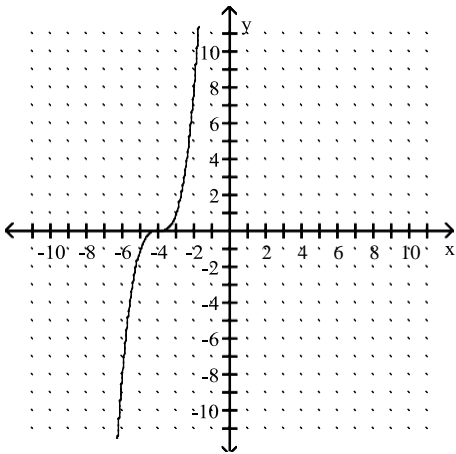

B)

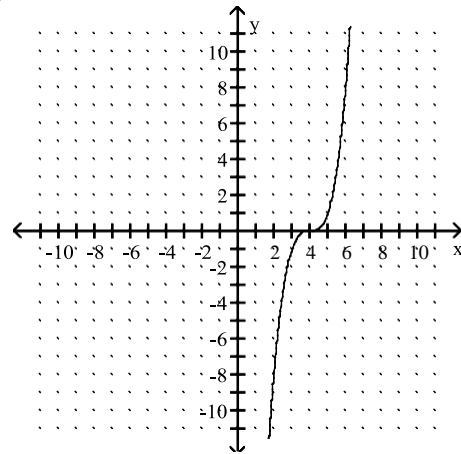

C)

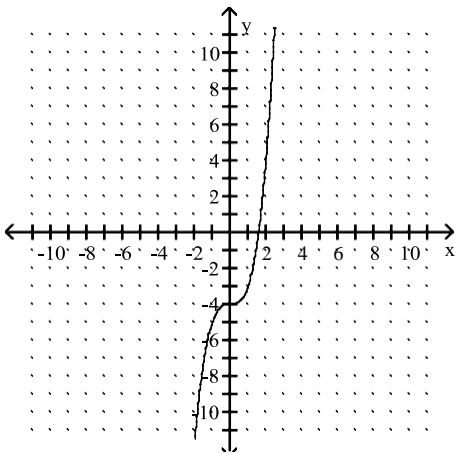

D)

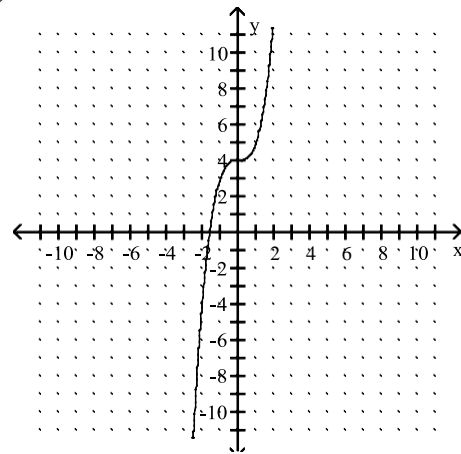

Answer: D

Find the domain, the range, and any intercepts.

76)

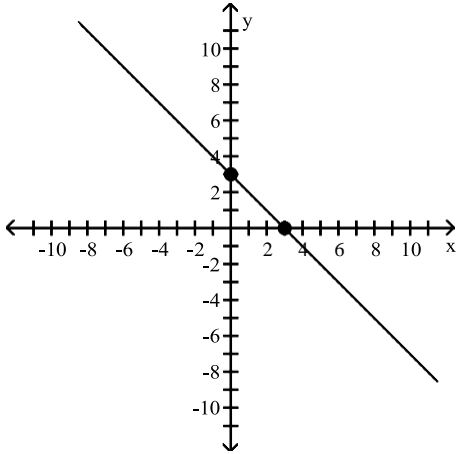

- A) domain: $(-\infty, \infty)$; range: $(-\infty, \infty)$; intercepts: $(0, 3)$, $(3, 0)$
- B) domain: $(-\infty, \infty)$; range: $(-\infty, \infty)$; intercept: $(0, 3)$
- C) domain: $(-\infty, \infty)$; range: $(-\infty, \infty)$; intercept: $(3, 0)$
- D) domain: $(3, \infty)$; range: $(3, \infty)$; intercepts: $(0, 3)$, $(3, 0)$

Answer: A

77)

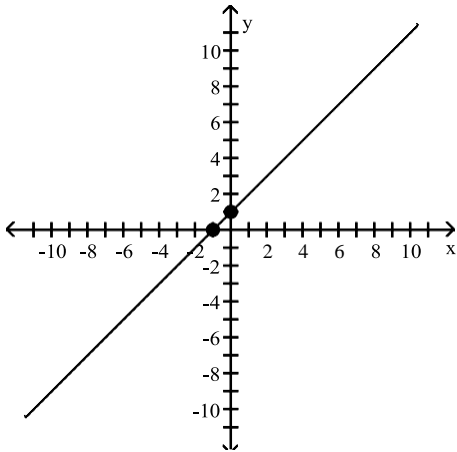

- A) domain: $(1, \infty)$; range: $(-1, \infty)$; intercepts: $(0, 1)$, $(-1, 0)$
- B) domain: $(-\infty, \infty)$; range: $(-\infty, \infty)$; intercept: $(-1, 0)$
- C) domain: $(-\infty, \infty)$; range: $(-\infty, \infty)$; intercepts: $(0, 1)$, $(-1, 0)$
- D) domain: $(-\infty, \infty)$; range: $(-\infty, \infty)$; intercept: $(0, 1)$

Answer: C

78)

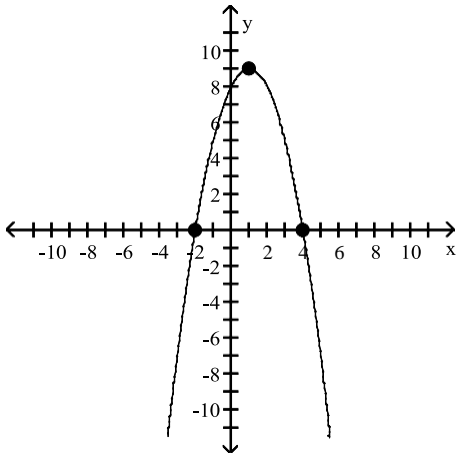

- A) domain: $(-\infty, 9]$; range: $(-\infty, \infty)$; intercepts: $(0, 8)$, $(-2, 0)$, $(4, 0)$
- B) domain: $(-\infty, \infty)$; range: $(-\infty, 9)$; intercepts: $(0, 8)$, $(-2, 0)$, $(4, 0)$
- C) domain: $(-\infty, \infty)$; range: $(-\infty, 9]$; intercepts: $(8, 0)$, $(0, -2)$, $(0, 4)$
- D) domain: $(-\infty, \infty)$; range: $(-\infty, 9]$; intercepts: $(0, 8)$, $(-2, 0)$, $(4, 0)$

Answer: D

79)

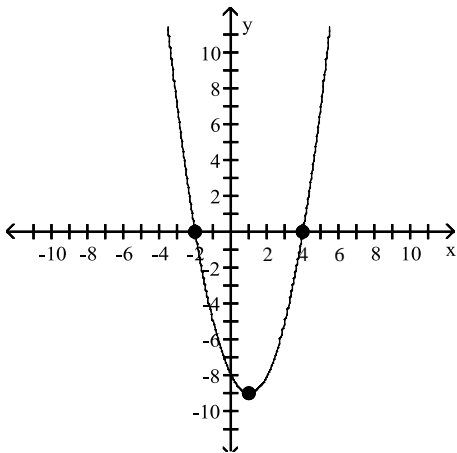

- A) domain: $(-\infty, \infty)$; range: $[-9, \infty)$; intercepts: $(-8, 0)$, $(0, -2)$, $(0, 4)$
- B) domain: $[-9, \infty)$; range: $(-\infty, \infty)$; intercepts: $(0, -8)$, $(-2, 0)$, $(4, 0)$
- C) domain: $(-\infty, \infty)$; range: $(-9, \infty)$; intercepts: $(0, -8)$, $(-2, 0)$, $(4, 0)$
- D) domain: $(-\infty, \infty)$; range: $[-9, \infty)$; intercepts: $(0, -8)$, $(-2, 0)$, $(4, 0)$

Answer: D

80)

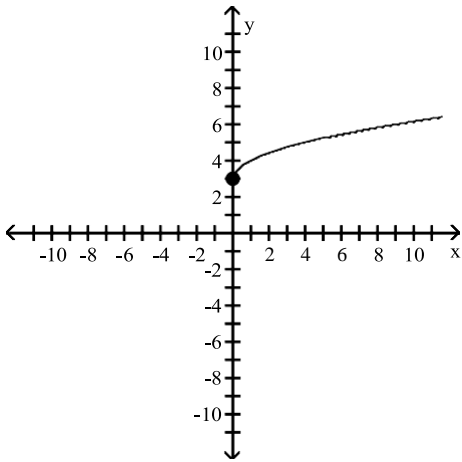

- A) domain: $[0, \infty)$; range: $(-\infty, \infty)$; intercept: $(3, 0)$
- C) domain: $[0, \infty)$; range: $[3, \infty)$; intercept: $(0, 3)$

- B) domain: $[0, \infty)$; range: $[0, \infty)$; intercept: $(0, 3)$
- D) domain: $(-\infty, \infty)$; range: $[3, \infty)$; intercept: $(0, 3)$

Answer: C

81)

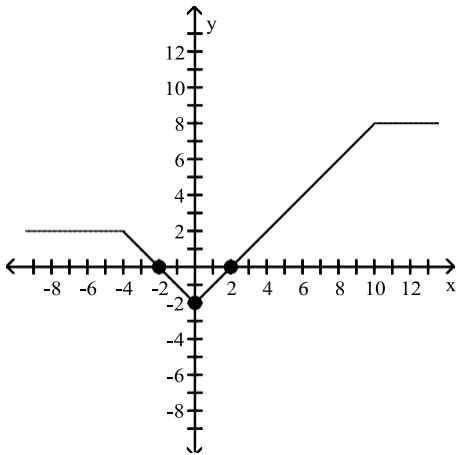

- A) domain: $(-\infty, \infty)$; range: $[-2, 8]$; intercept: $(0, -2)$
- B) domain: $(-\infty, \infty)$; range: $[-2, 8]$; intercepts: $(0, -2)$, $(-2, 0)$, $(2, 0)$
- C) domain: $(-\infty, \infty)$; range: $[-2, \infty)$; intercepts: $(0, -2)$, $(-2, 0)$, $(2, 0)$
- D) domain: $(-\infty, \infty)$; range: $[2, 8]$; intercepts: $(0, -2)$, $(-2, 0)$, $(2, 0)$

Answer: B

Match the graph to the function listed whose graph most resembles the one given.

82)

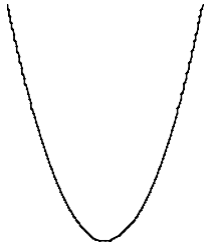

- A) absolute value function
- C) square function

- B) cube function
- D) reciprocal function

Answer: C

83)



- A) linear function
- C) constant function

- B) reciprocal function
- D) absolute value function

Answer: C

84)



- A) square root function
- C) cube function

- B) square function
- D) cube root function

Answer: A

85)

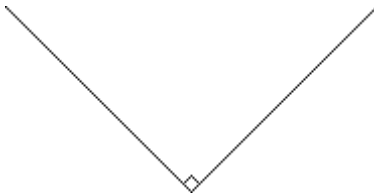

- A) absolute value function
- C) square function

- B) linear function
- D) reciprocal function

Answer: A

86)

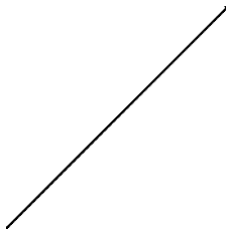

- A) linear function
- C) constant function

Answer: A

- B) absolute value function
- D) reciprocal function

87)



- A) cube function
- C) square function

Answer: A

- B) square root function
- D) cube root function

88)

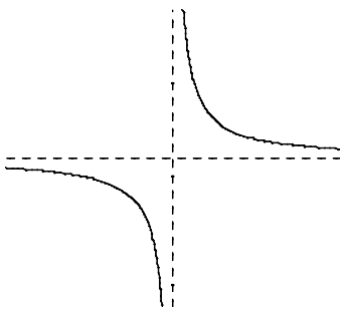

- A) square function
- C) reciprocal function

Answer: C

- B) absolute value function
- D) square root function

89)



- A) cube function
- C) cube root function

Answer: C

- B) square root function
- D) square function

Sketch the graph of the function. Label at least three points.

90) $f(x) = x^2$

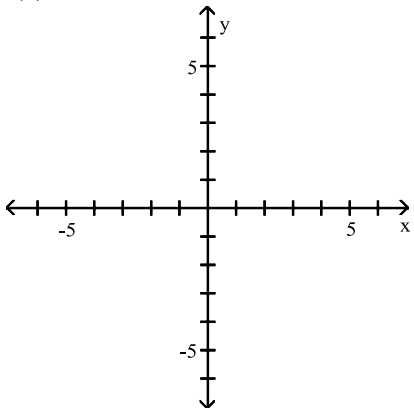

A)

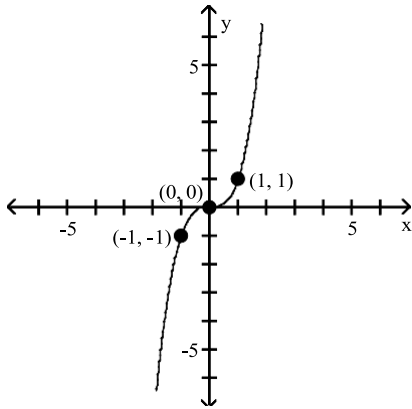

B)

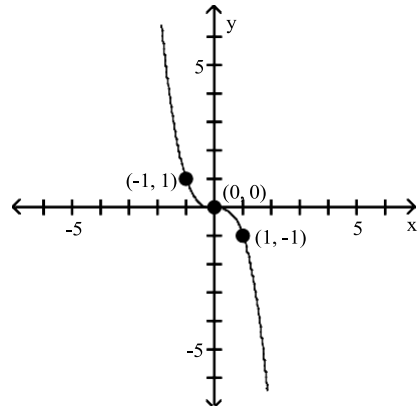

C)

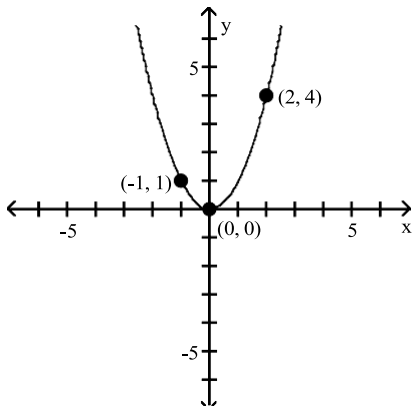

D)

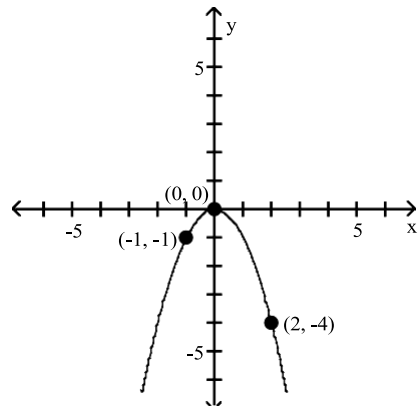

Answer: C

91) $f(x) = x^3$

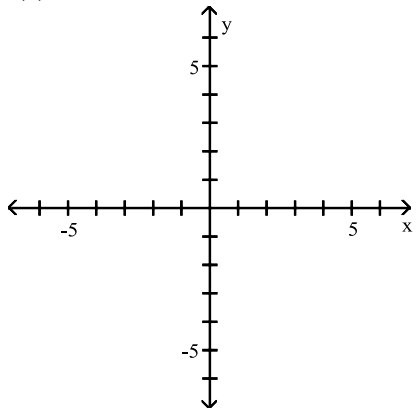

A)

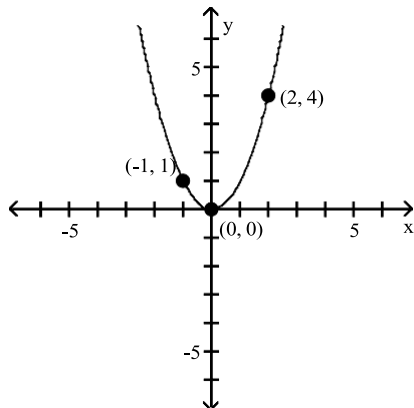

B)

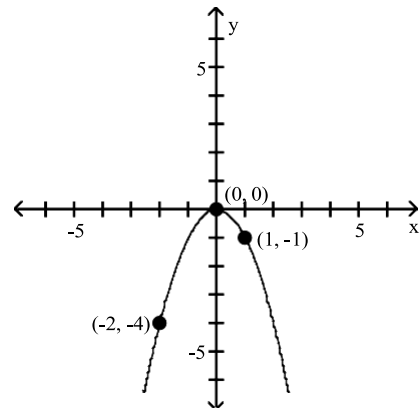

C)

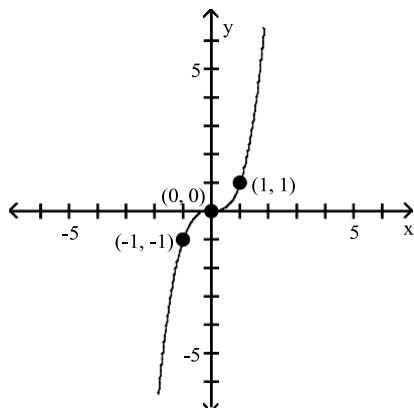

D)

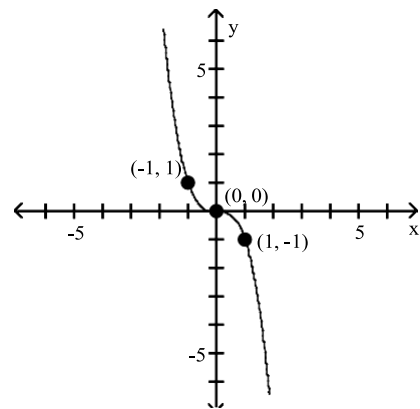

Answer: C

92) $f(x) = \sqrt{x}$

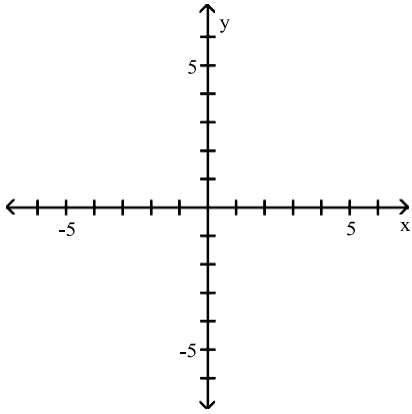

A)

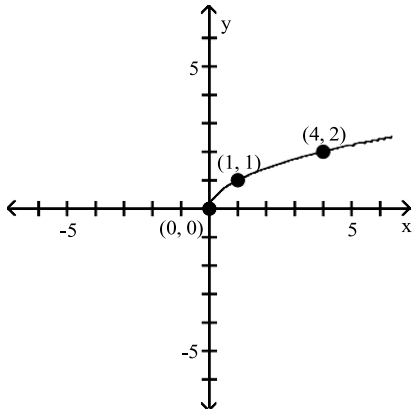

C)

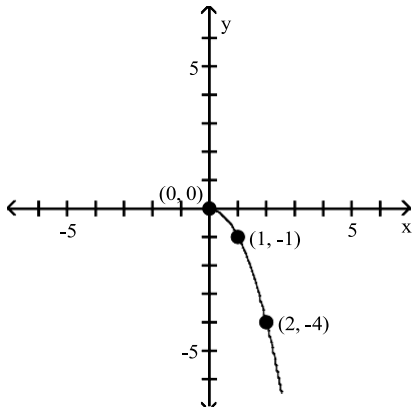

B)

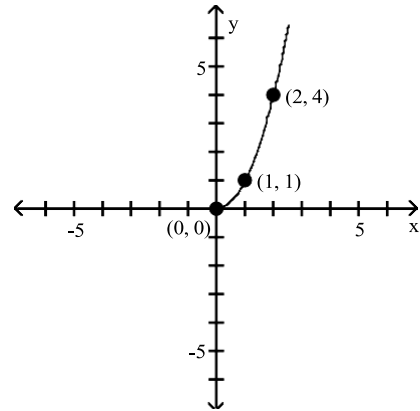

D)

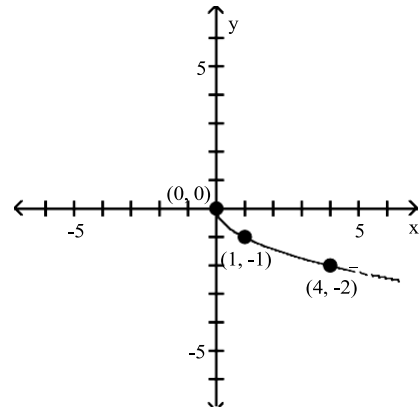

Answer: A

93) $f(x) = \sqrt[3]{x}$

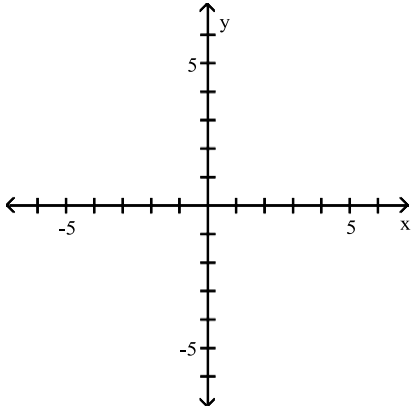

A)

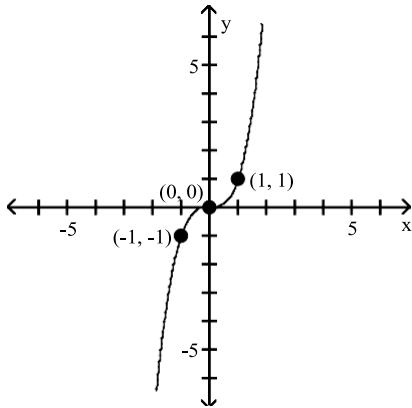

C)

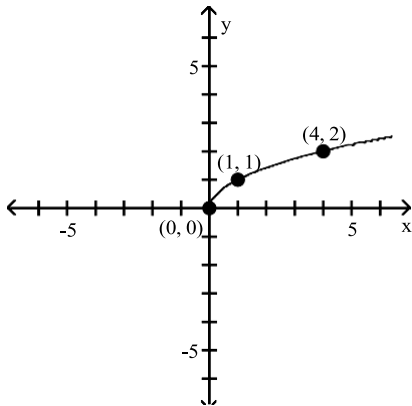

B)

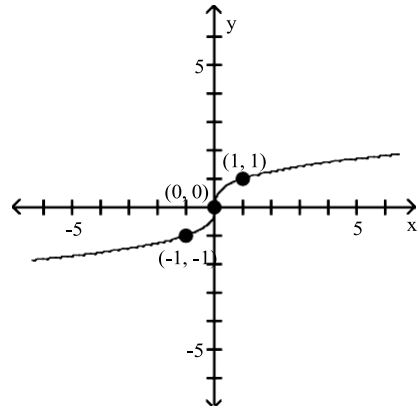

D)

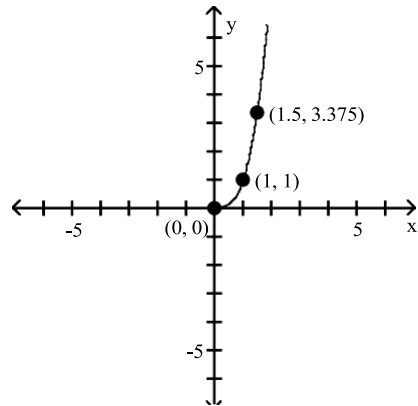

Answer: B

94) $f(x) = \frac{1}{x}$

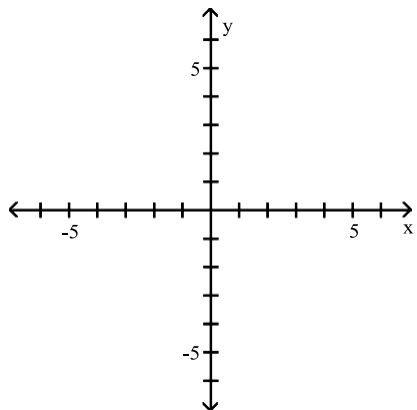

A)

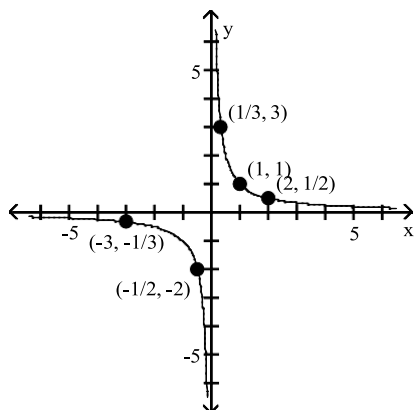

C)

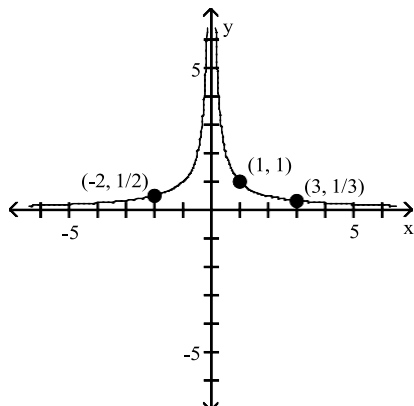

B)

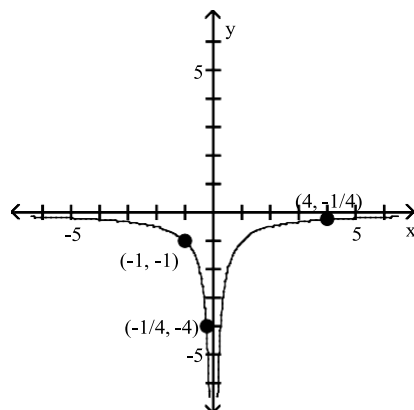

D)

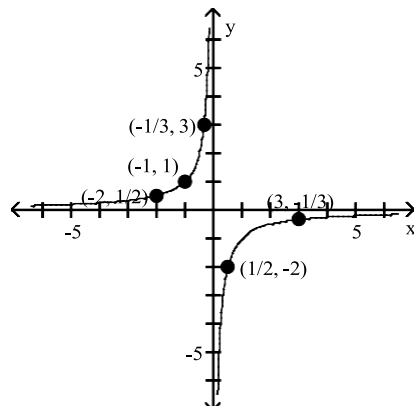

Answer: A

95) $f(x) = |x|$

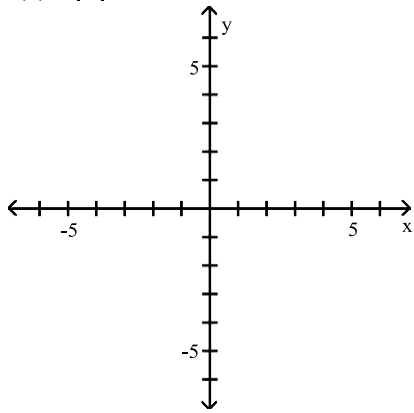

A)

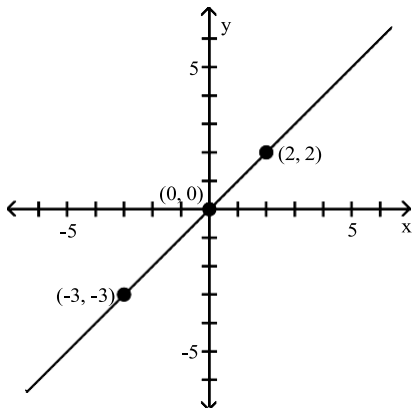

C)

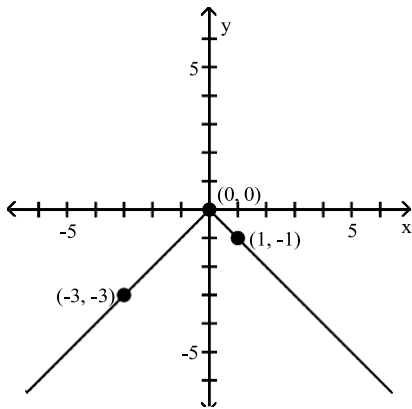

Answer: B

B)

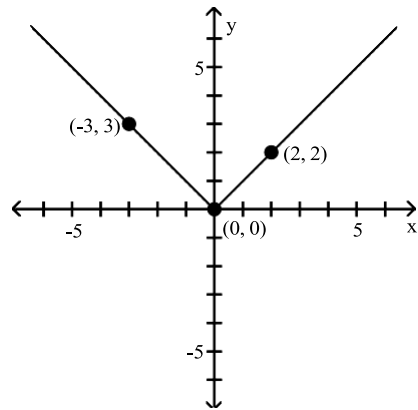

D)

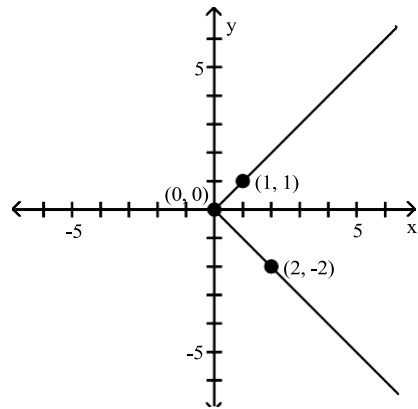

The graph of a function f is given. Use the graph to answer the question.

96) Use the graph of f given below to find $f(20)$.

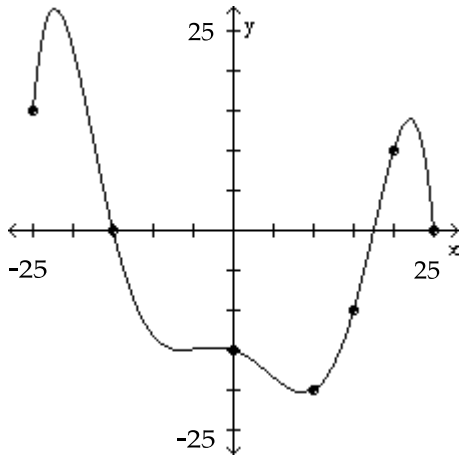

A) 35

B) 10

C) 25

D) 20

Answer: B

97) Is $f(80)$ positive or negative?

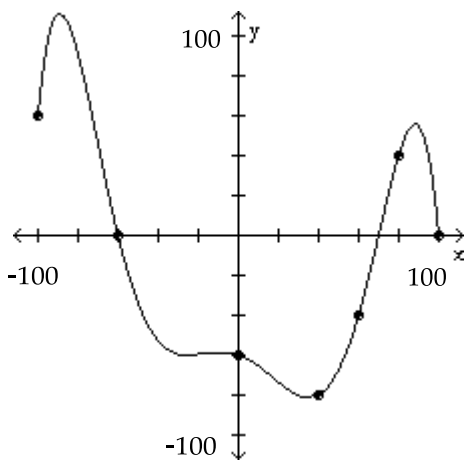

A) positive

B) negative

Answer: A

98) Is $f(6)$ positive or negative?

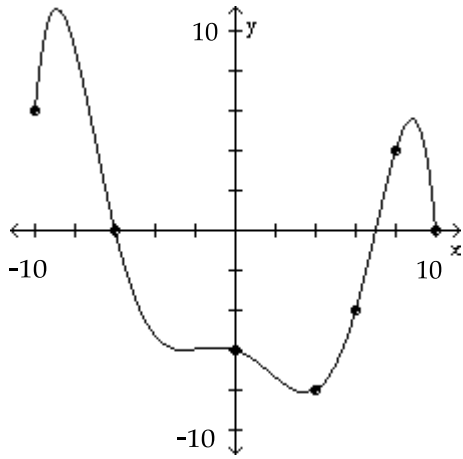

A) positive

B) negative

Answer: B

99) For what numbers x is $f(x) = 0$?

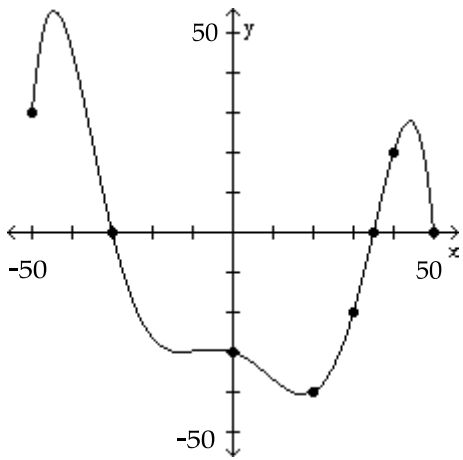

A) -30

B) -50, -30, 35, 50

C) -30, 35

D) -30, 35, 50

Answer: D

100) For what numbers x is $f(x) > 0$?

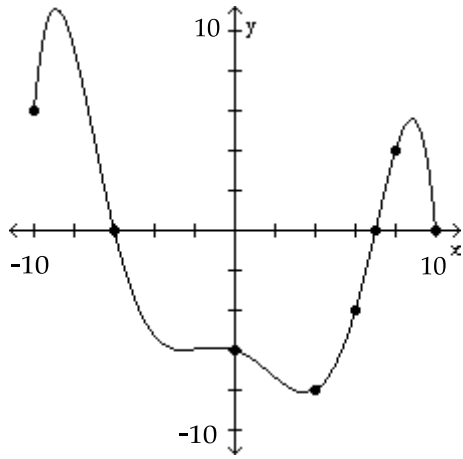

- A) $(-\infty, -6)$ B) $(-6, 7)$ C) $(-6, \infty)$ D) $[-10, -6), (7, 10)$
 Answer: D

101) For what numbers x is $f(x) < 0$?

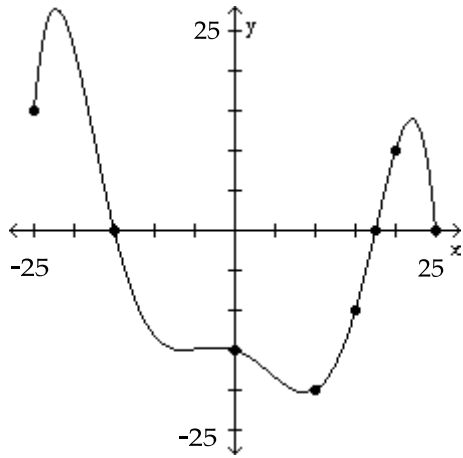

- A) $[-25, -15), (17.5, 25)$ B) $(-15, 17.5)$
 C) $(-\infty, -15)$ D) $(-15, \infty)$
 Answer: B

102) What is the domain of f ?

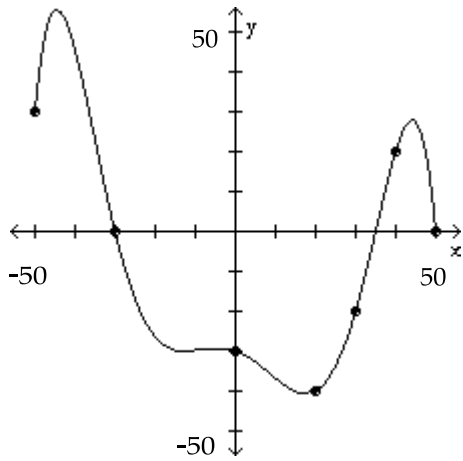

- A) all real numbers B) $\{x \mid x \geq 0\}$ C) $\{x \mid -60 \leq x \leq 55\}$ D) $\{x \mid -50 \leq x \leq 50\}$
Answer: D

103) What are the x-intercepts?

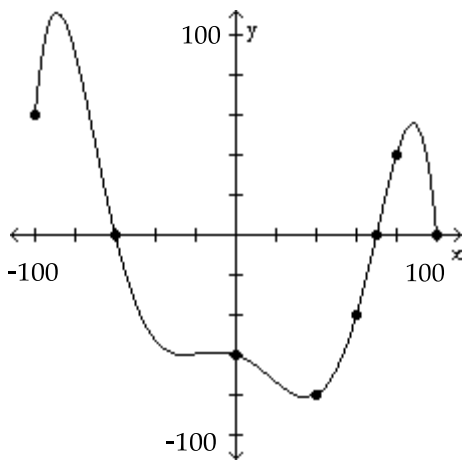

- A) -100, -60, 70, 100 B) -60, 70 C) -60 D) -60, 70, 100
Answer: D

104) What is the y-intercept?

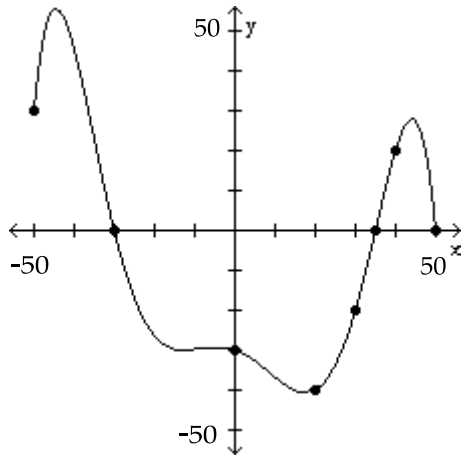

- A) 50 B) -40 C) 35 D) -30
- Answer: D

105) How often does the line $y = -50$ intersect the graph?

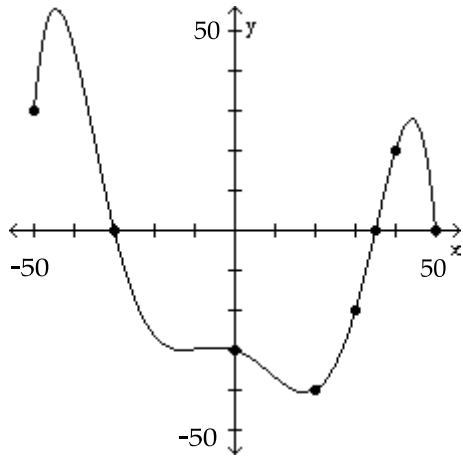

- A) once B) twice C) three times D) does not intersect
- Answer: D

106) How often does the line $y = 4$ intersect the graph?

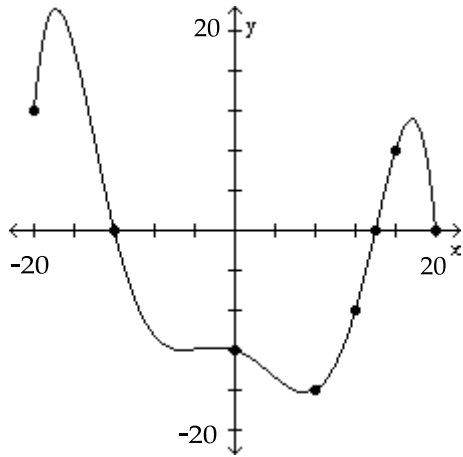

- A) once B) twice C) three times D) does not intersect
- Answer: C

107) For which of the following values of x does $f(x) = -40$?

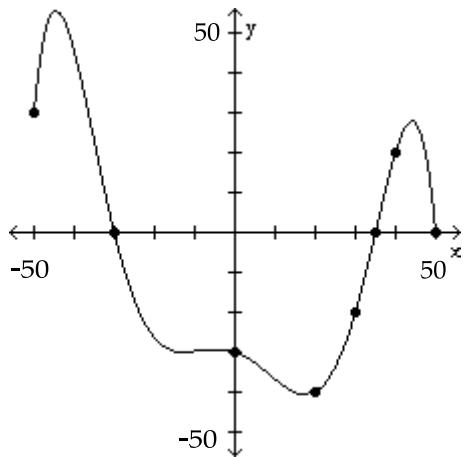

- A) 30 B) 0 C) 20 D) -40
- Answer: C

Answer the question about the given function.

108) Given the function $f(x) = -6x^2 - 12x - 5$, is the point $(-1, 1)$ on the graph of f ?

A) Yes B) No

Answer: A

109) Given the function $f(x) = -7x^2 + 14x + 1$, is the point $(2, -13)$ on the graph of f ?

A) Yes B) No

Answer: B

110) Given the function $f(x) = 2x^2 + 4x + 2$, if $x = -1$, what is $f(x)$? What point is on the graph of f ?

A) 8; $(-1, 8)$ B) 0; $(0, -1)$ C) 0; $(-1, 0)$ D) 8; $(8, -1)$

Answer: C

- 111) Given the function $f(x) = -7x^2 + 14x - 6$, what is the domain of f ?
- A) $[1, \infty)$ B) $(-\infty, \infty)$ C) $[-1, \infty)$ D) $(-\infty, 1]$

Answer: B

- 112) Given the function $f(x) = x^2 + 2x - 99$, list the x -intercepts, if any, of the graph of f .
- A) $(-11, 0), (1, 0)$ B) $(-11, 0), (9, 0)$ C) $(11, 0), (-9, 0)$ D) $(11, 0), (9, 0)$

Answer: B

- 113) Given the function $f(x) = 6x^2 - 12x - 4$, list the y -intercept, if there is one, of the graph of f .
- A) -10 B) 8 C) -4 D) 14

Answer: B

- 114) Given the function $f(x) = \frac{x^2 - 5}{x - 2}$, is the point $(1, 4)$ on the graph of f ?

- A) Yes B) No

Answer: A

- 115) Given the function $f(x) = \frac{x^2 - 9}{x + 1}$, is the point $(2, \frac{13}{3})$ on the graph of f ?

- A) Yes B) No

Answer: B

- 116) Given the function $f(x) = \frac{x^2 - 8}{x + 1}$, if $x = 2$, what is $f(x)$? What point is on the graph of f ?

- A) $4; (2, 4)$ B) $4; (4, 2)$ C) $-\frac{4}{3}; \left(-\frac{4}{3}, 2\right)$ D) $-\frac{4}{3}; 2, -\frac{4}{3}$

Answer: D

- 117) Given the function $f(x) = \frac{x^2 + 3}{x + 7}$, list the x -intercepts, if any, of the graph of f .

- A) $(3, 0), (-3, 0)$ B) $(-7, 0)$ C) no x -intercepts D) $(-\sqrt{3}, 0)$

Answer: C

- 118) Given the function $f(x) = \frac{x^2 + 8}{x - 7}$, list the y -intercept, if there is one, of the graph of f .

- A) $\left(-\frac{8}{7}, 0\right)$ B) $\left(0, -\frac{8}{7}\right)$ C) $(0, -8)$ D) $(0, 7)$

Answer: B

Find the domain of the function.

- 119) Nina is a commissioned salesperson. She earns a base salary of \$330 per week plus 10% of the sales price of the

items sold. Her gross salary G as a function of the price p of items sold is given by $G(p) = 330 + 0.10p$. What is the domain of the function?

A) $(0, \infty)$

B) $[0, \infty)$

C) $[330, \infty)$

D) $(330, \infty)$

Answer: B

120) Suppose the function $D(p) = 1300 - 10p$ represents the demand for hot dogs, whose price is p , at a baseball game. Find the domain of the function.

A) $[0, 10]$

B) $[0, \infty)$

C) $[0, 1300]$

D) $[0, 130]$

Answer: D

Match the function with the graph that best describes the situation.

121) The amount of rainfall as a function of time, if the rain fell more and more softly.

A)

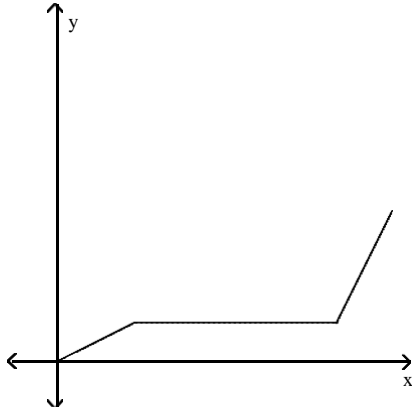

B)

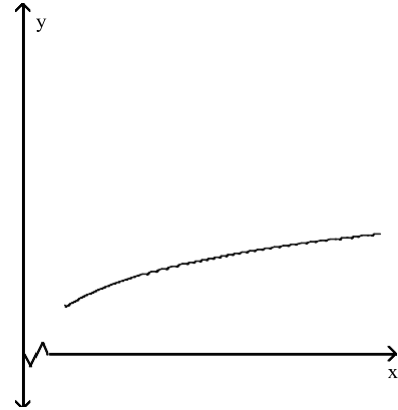

C)

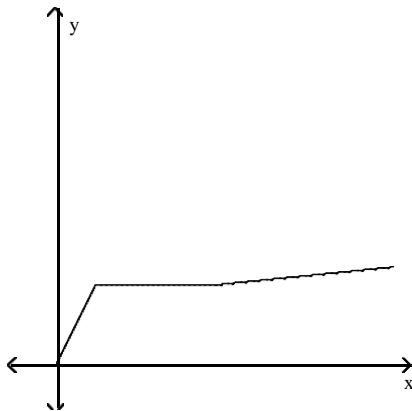

D)

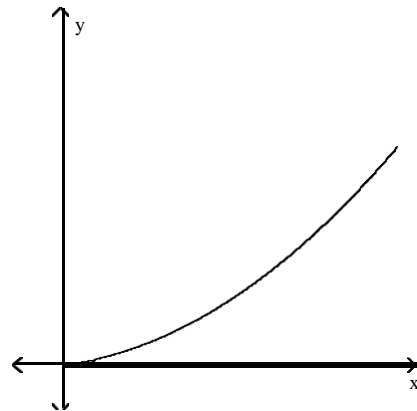

Answer: B

122) The height of an animal as a function of time.

A)

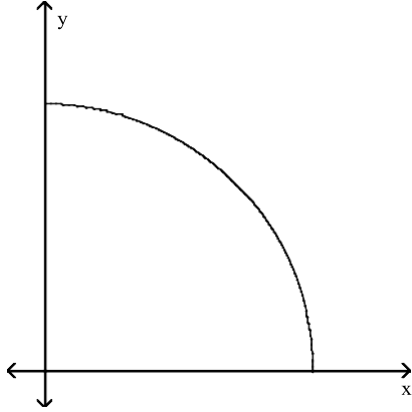

B)

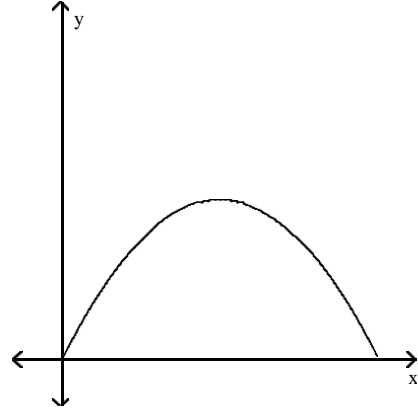

C)

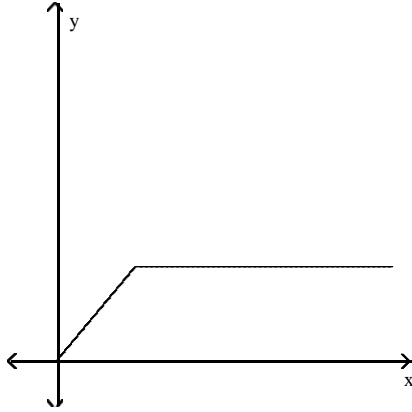

D)

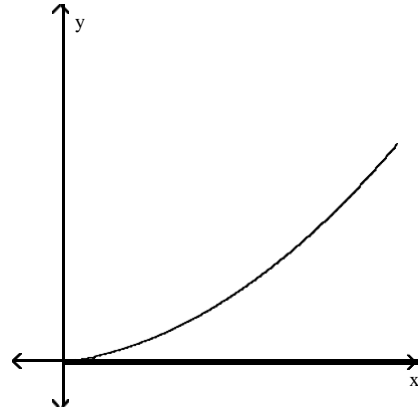

Answer: C

SHORT ANSWER. Write the word or phrase that best completes each statement or answers the question.

Solve.

123) Michael decides to walk to the mall to do some errands. He leaves home, walks 3 blocks in 10 minutes at a constant speed, and realizes that he forgot his wallet at home. So Michael runs back in 8 minutes. At home, it takes him 3 minutes to find his wallet and close the door. Michael walks 5 blocks in 14 minutes and then decides to jog to the mall. It takes him 12 minutes to get to the mall which is 5 blocks away. Draw a graph of Michael's distance from home (in blocks) as a function of time.

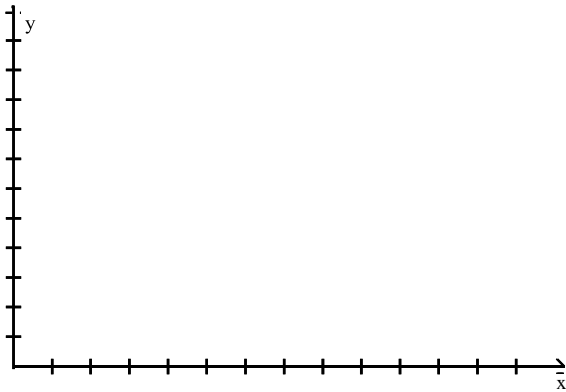

Answer:

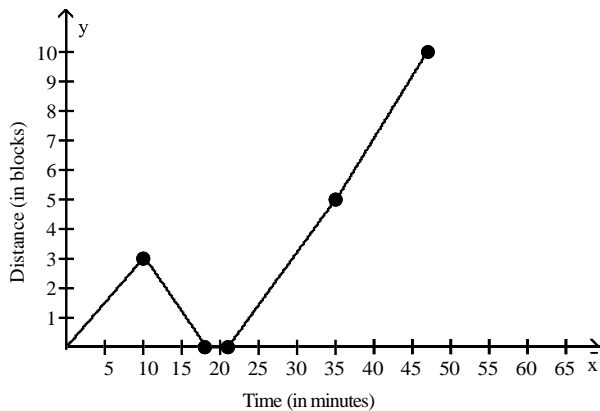

MULTIPLE CHOICE. Choose the one alternative that best completes the statement or answers the question.

Graph the linear function.

124) $F(x) = -2x + 8$

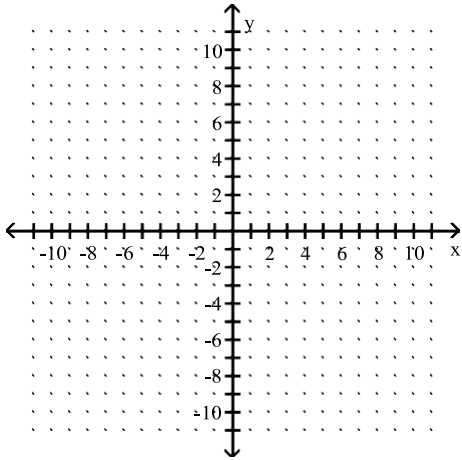

A)

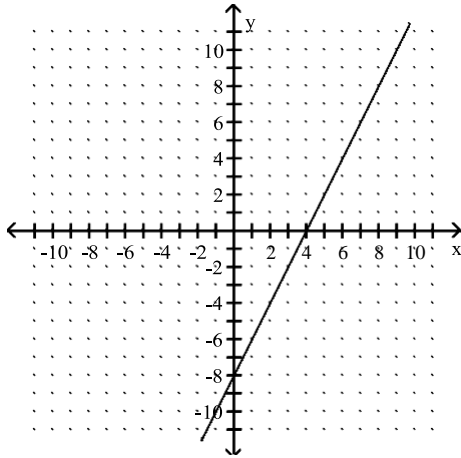

B)

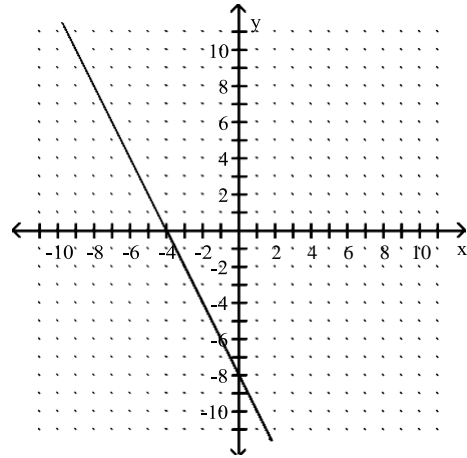

C)

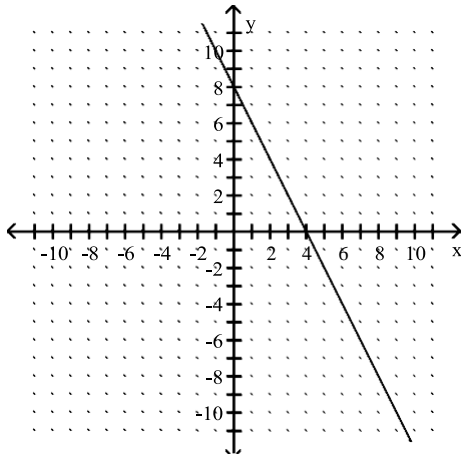

D)

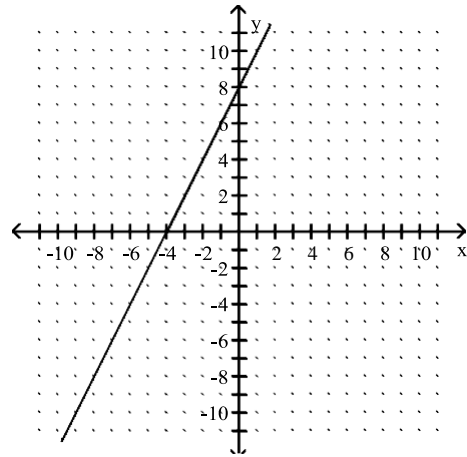

Answer: C

125) $G(x) = -5x - 10$

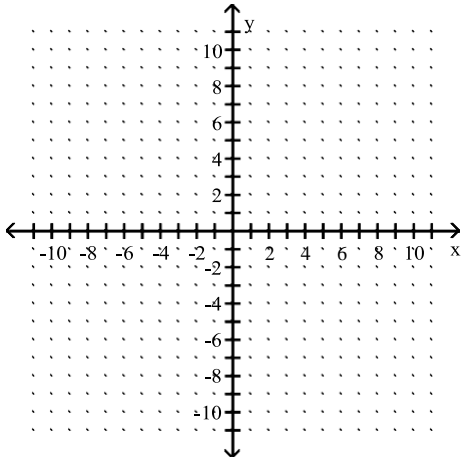

A)

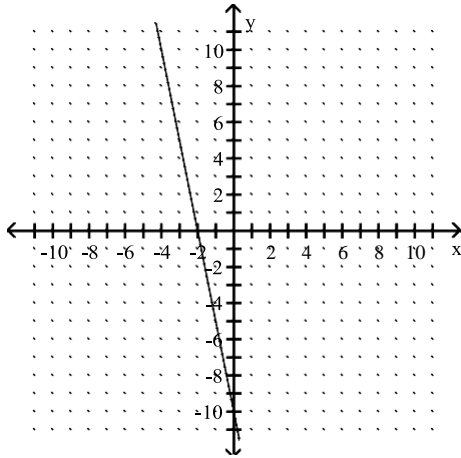

B)

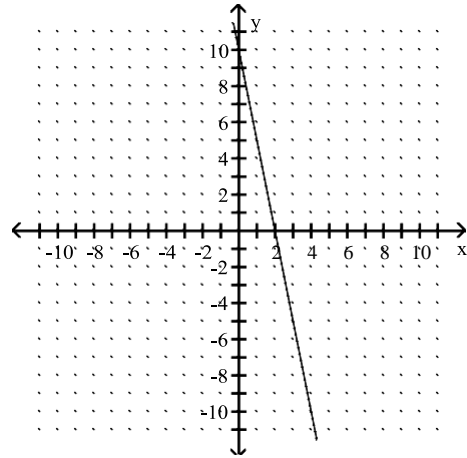

C)

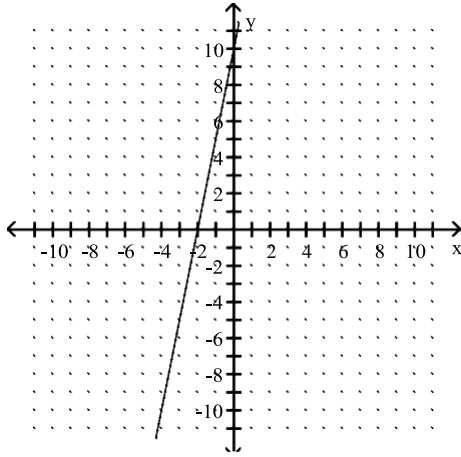

D)

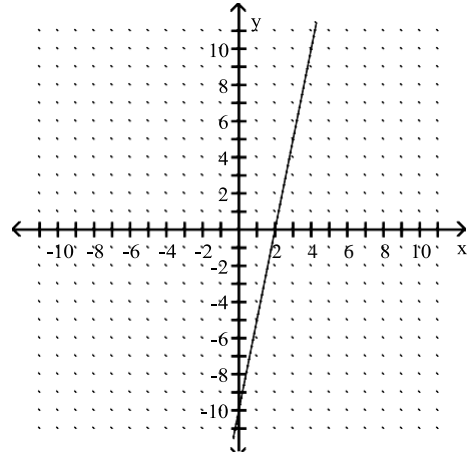

Answer: A

126) $H(x) = 4$

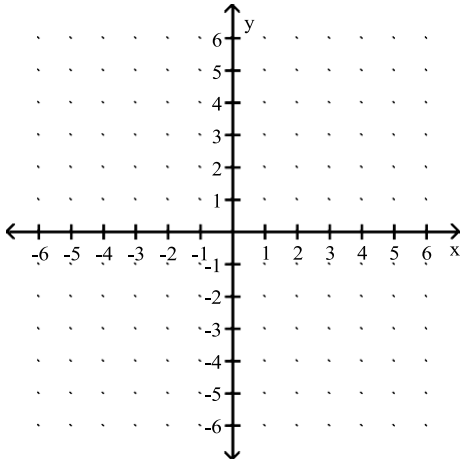

A)

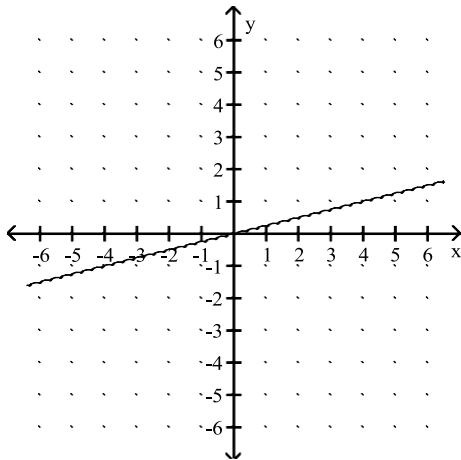

C)

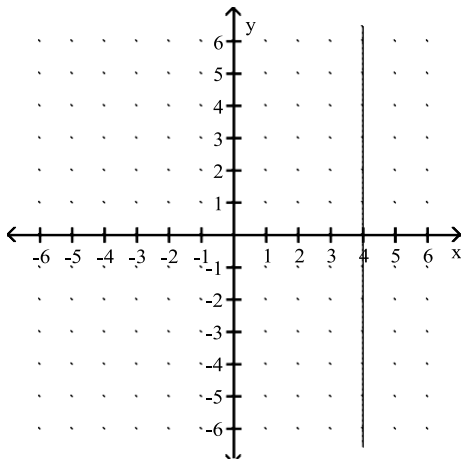

B)

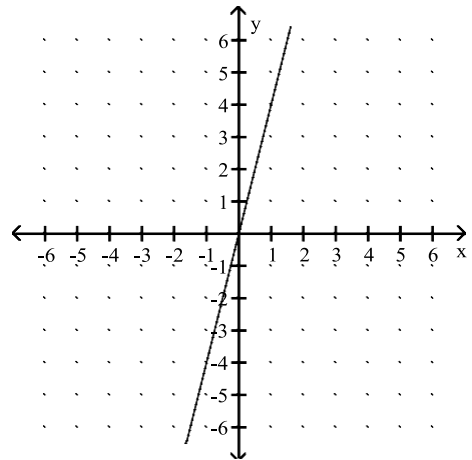

D)

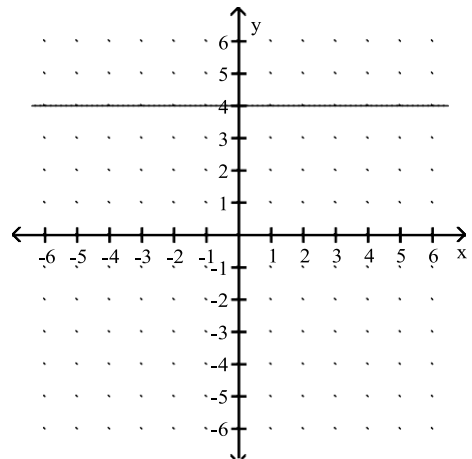

Answer: D

127) $f(x) = \frac{1}{2}x + 6$

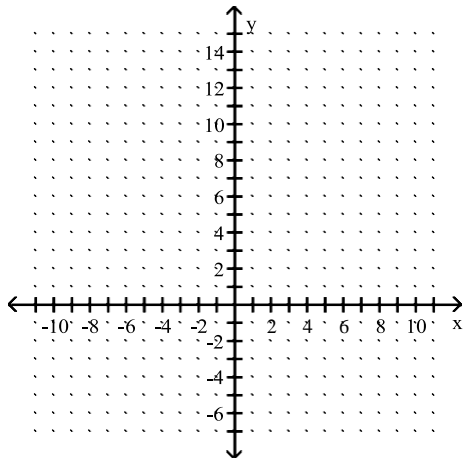

A)

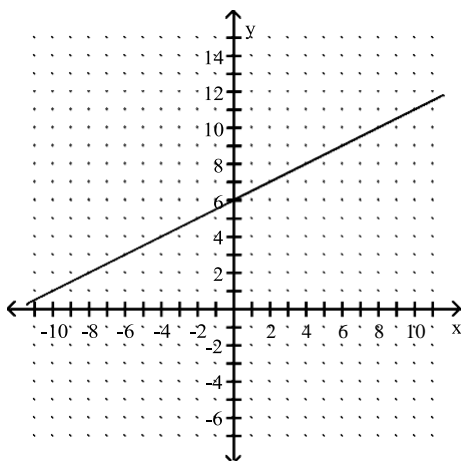

B)

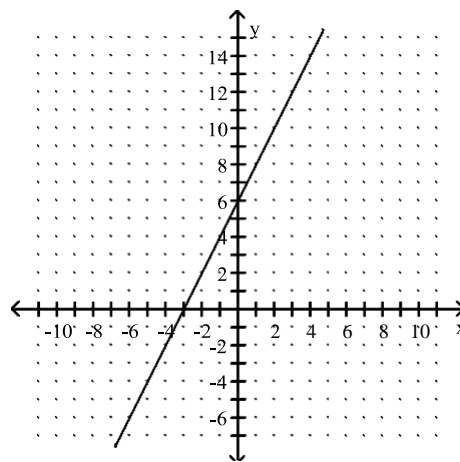

C)

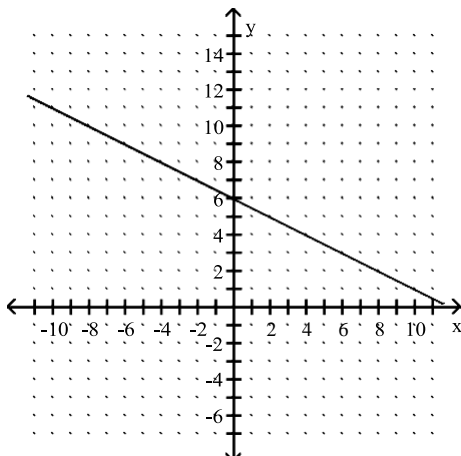

D)

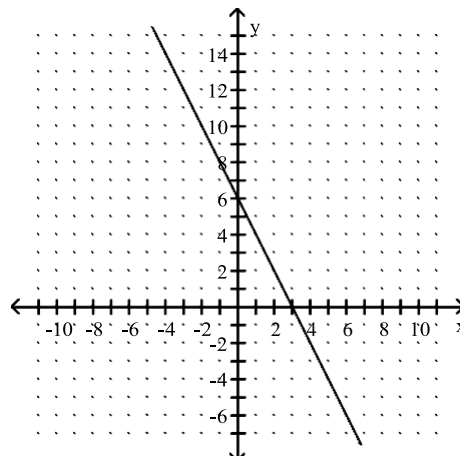

Answer: A

128) $g(x) = \frac{1}{2}x - 6$

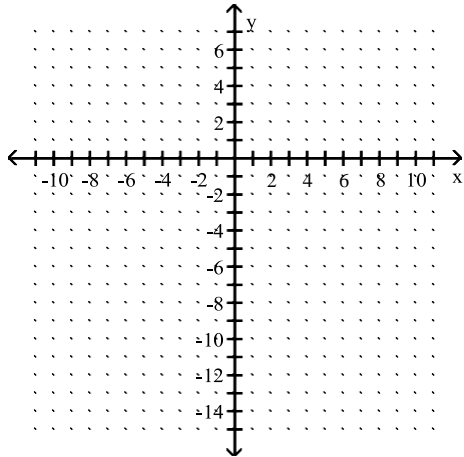

A)

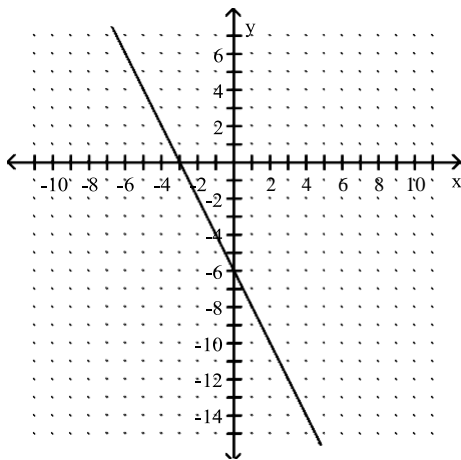

C)

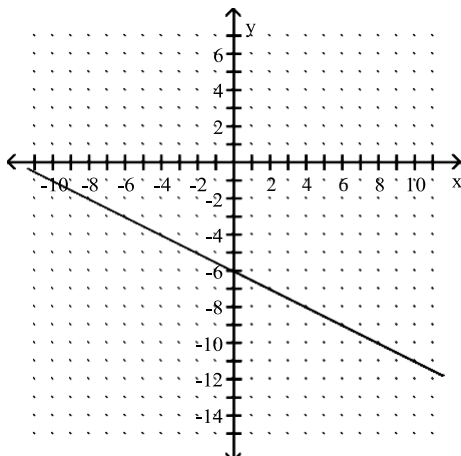

B)

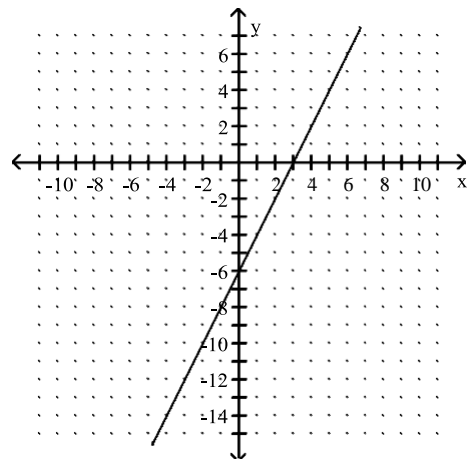

D)

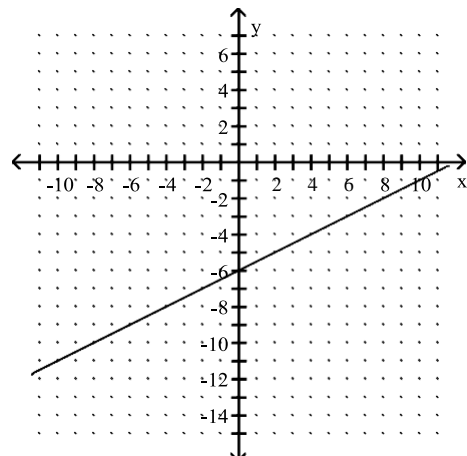

Answer: D

129) $P(x) = \frac{3}{4}x - 2$

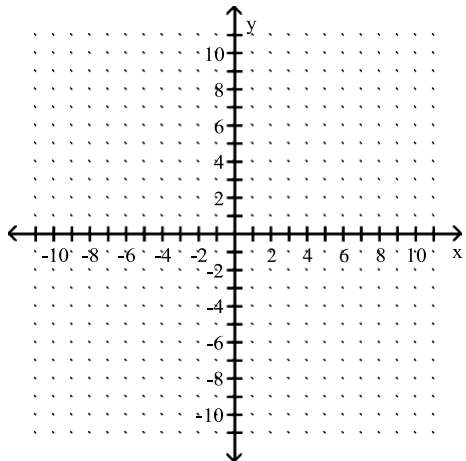

A)

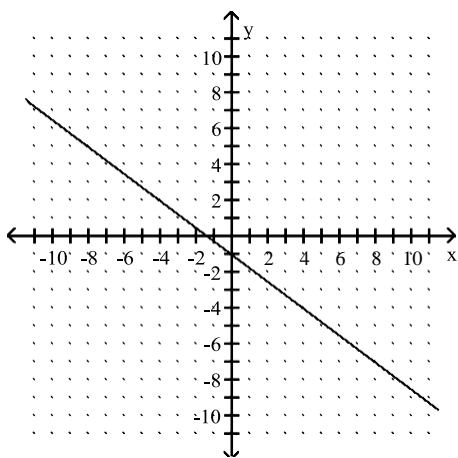

B)

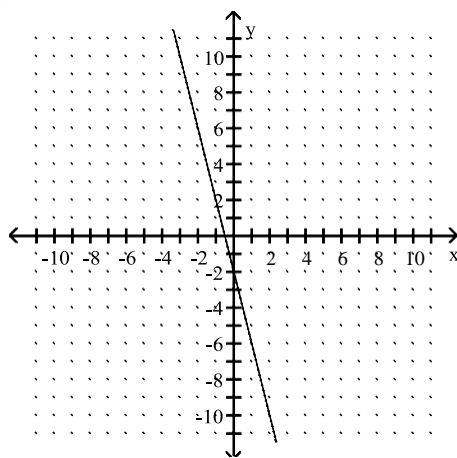

C)

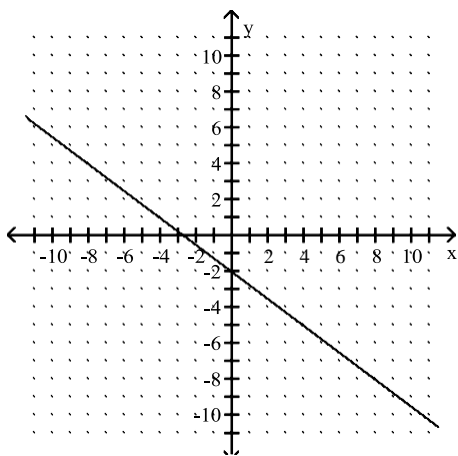

D)

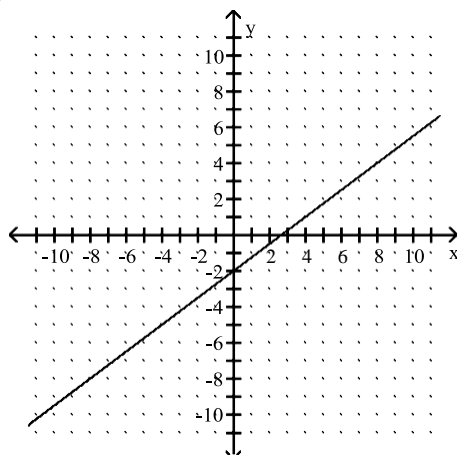

Answer: D

130) $F(x) = -\frac{2}{5}x - 2$

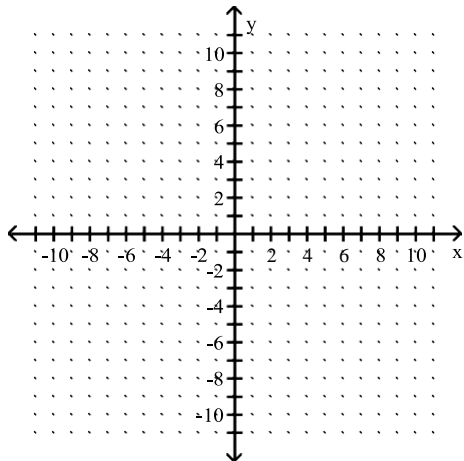

A)

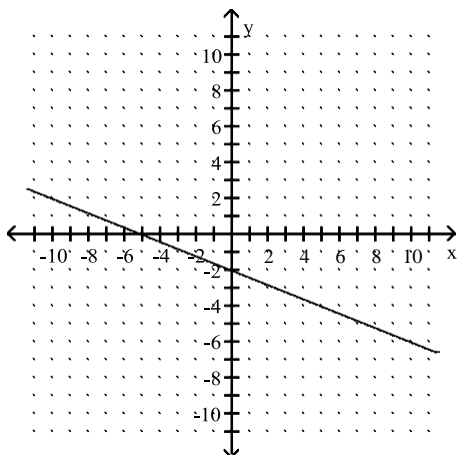

B)

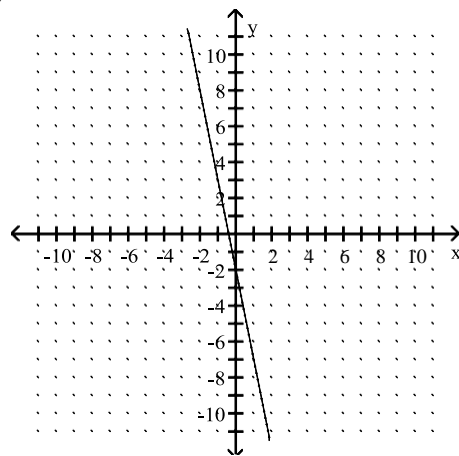

C)

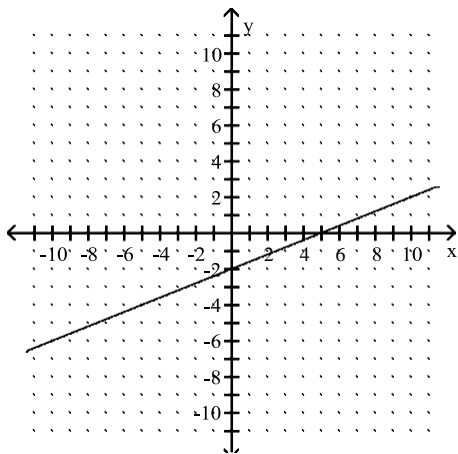

D)

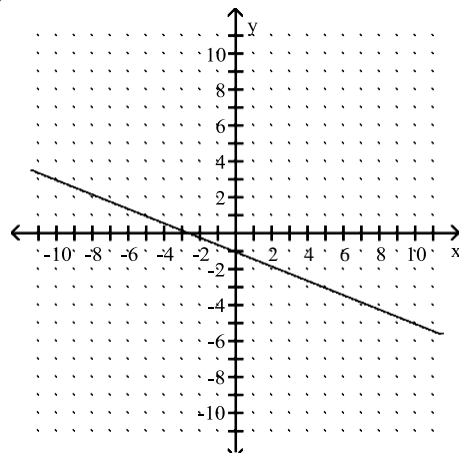

Answer: A

131) $G(x) = -\frac{5}{7}x$

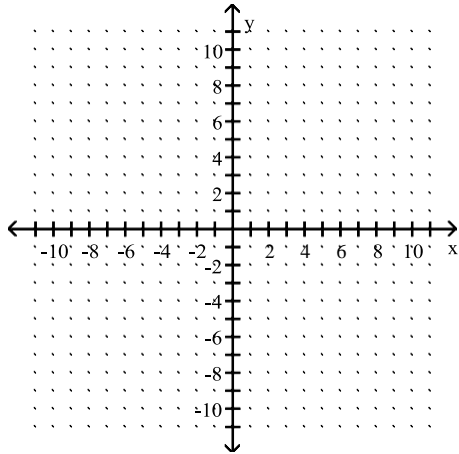

A)

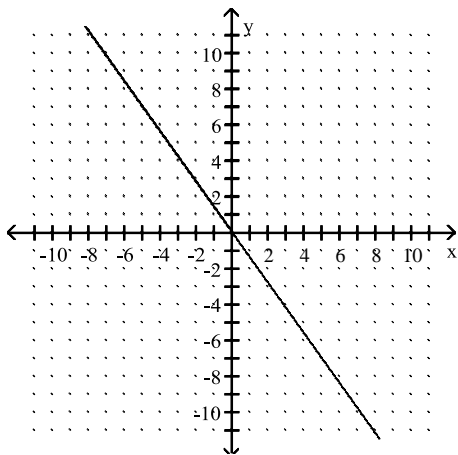

B)

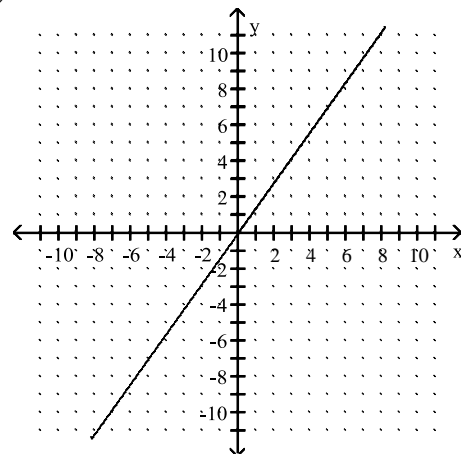

C)

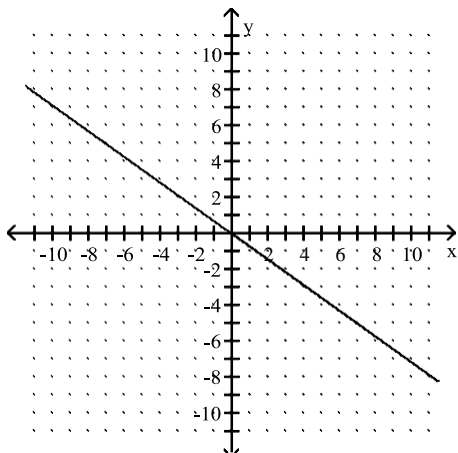

D)

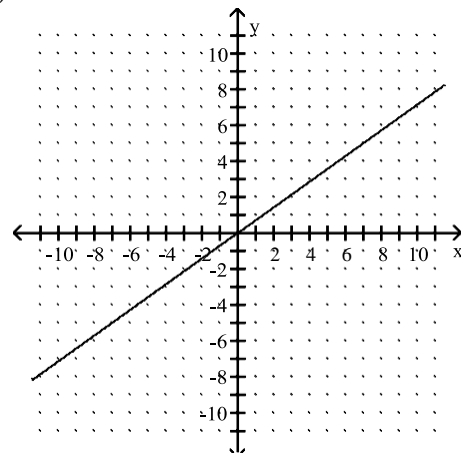

Answer: C

132) $f(x) = \frac{7}{6}x$

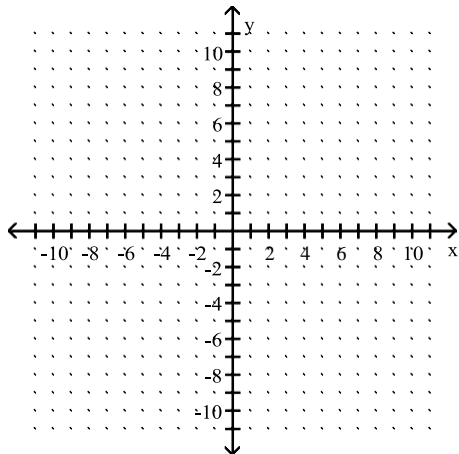

A)

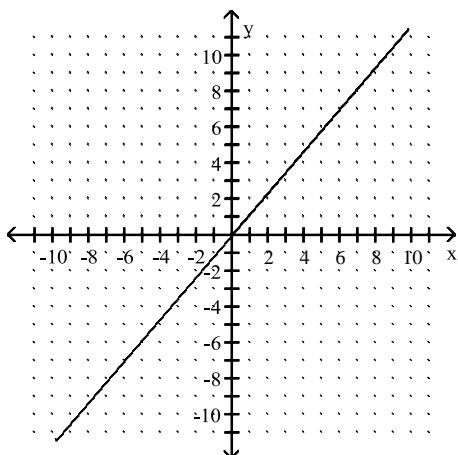

B)

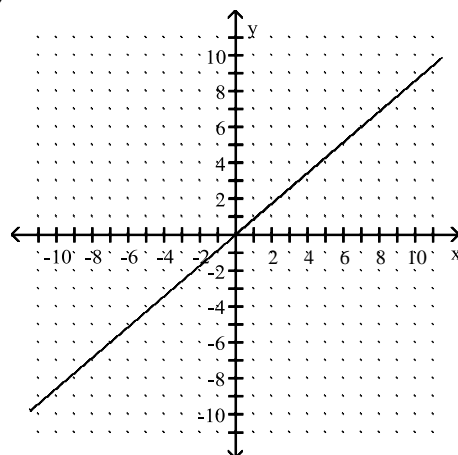

C)

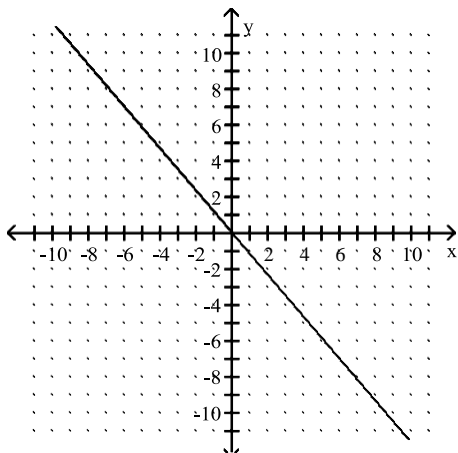

D)

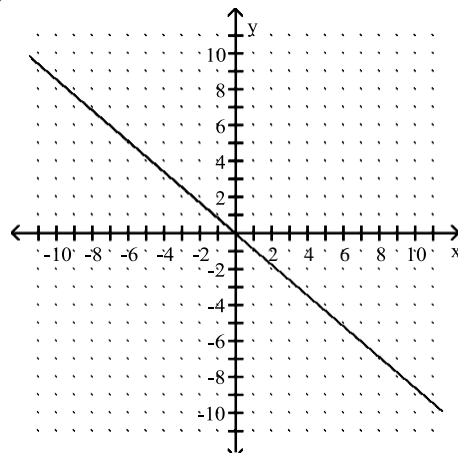

Answer: A

Find the zero of the linear function.

133) $f(x) = 8x - 72$

A) -9

B) 9

C) -64

D) 64

Answer: B

- 134) $g(x) = 3x + 27$
 A) 9 B) 24 C) -24 D) -9
 Answer: D
- 135) $H(x) = -6x + 54$
 A) 48 B) -9 C) -48 D) 9
 Answer: D
- 136) $G(x) = -8x - 48$
 A) -40 B) -6 C) 40 D) 6
 Answer: B
- 137) $s(t) = \frac{1}{6}t - 8$
 A) -48 B) 2 C) -2 D) 48
 Answer: D
- 138) $p(q) = \frac{1}{6}q + 7$
 A) 42 B) 1 C) -1 D) -42
 Answer: D
- 139) $h(t) = -\frac{1}{8}t + 9$
 A) -72 B) -1 C) 1 D) 72
 Answer: D
- 140) $f(z) = -\frac{1}{7}z - 9$
 A) -63 B) -2 C) 63 D) 2
 Answer: A
- 141) $F(t) = \frac{2}{3}t + 6$
 A) 9 B) -9 C) -4 D) 4
 Answer: B
- 142) $P(z) = -\frac{2}{3}z + 6$
 A) 4 B) -4 C) 9 D) -9
 Answer: C
- 143) $g(t) = -\frac{5}{3}t - 15$
 A) -25 B) -9 C) 9 D) 25
 Answer: B

144) $f(x) = \frac{3}{2}x - 6$

A) 4

B) 9

C) -4

D) -9

Answer: A

Solve.

145) The cost of renting a certain type of car is \$31 per day plus \$0.08 per mile. Find a linear function that expresses the cost C of renting a car for one day as a function of the number of miles driven x .

A) $C(x) = 0.08x + 31$

B) $C(x) = 31x + 0.08$

C) $C(x) = (x + 0.08) + 31$

D) $C(x) = 0.08x + 31x$

Answer: A

146) The cost of renting a certain type of car is \$40 per day plus \$0.10 per mile. A linear function that expresses the cost C of renting a car for one day as a function of the number of miles driven x is $C(x) = 0.10x + 40$. What are the independent and dependent variables?

A) The independent variable is the number of days, x . The dependent variable is the cost C .

B) The independent variable is the number of miles driven, x . The dependent variable is the cost C .

C) The independent variable is the cost, C . The dependent variable is the number of miles driven, x .

D) The independent variable is 40. The dependent variable is 0.10.

Answer: B

147) The cost of renting a certain type of car is \$36 per day plus \$0.08 per mile. A linear function that expresses the cost C of renting a car for one day as a function of the number of miles driven x is $C(x) = 0.08x + 36$. What is the implied domain of this linear function?

A) $[36, \infty)$

B) $[0, 500]$

C) $(0, \infty)$

D) $[0, \infty)$

Answer: D

148) The cost of renting a certain type of car is \$37 per day plus \$0.08 per mile. A linear function that expresses the cost C of renting a car for one day as a function of the number of miles driven x is $C(x) = 0.08x + 37$. What is the rental cost for one day if 310 miles are driven?

A) \$24.80

B) \$56.06

C) \$65.77

D) \$61.80

Answer: D

149) The cost of renting a certain type of car is \$35 per day plus \$0.07 per mile. A linear function that expresses the cost C of renting a car for one day as a function of the number of miles driven x is $C(x) = 0.07x + 35$. How many miles were driven if the rental cost for one day is \$63.00?

A) 400 miles

B) 900 miles

C) 438 miles

D) 414 miles

Answer: A

150) The cost of renting a certain type of car is \$41 per day plus \$0.09 per mile. A linear function that expresses the cost C of renting a car for one day as a function of the number of miles driven x is $C(x) = 0.09x + 41$. Graph the linear function. Use a domain of $0 \leq x \leq 500$.

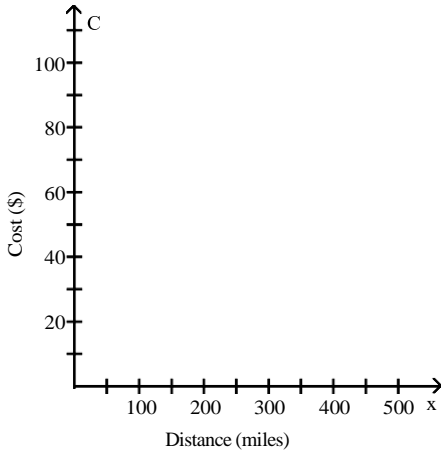

A)

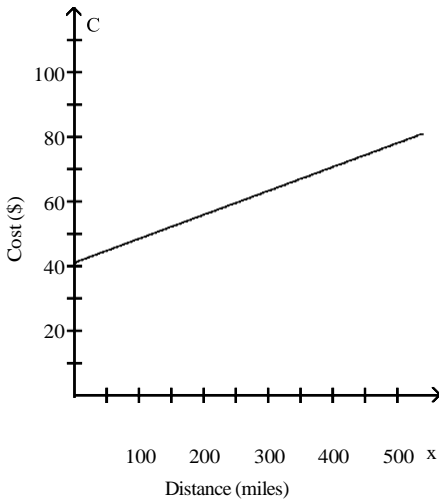

B)

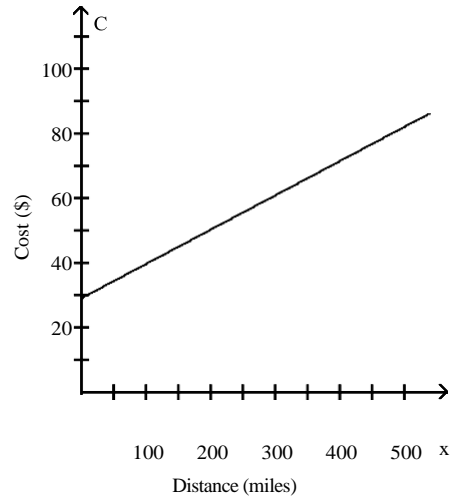

C)

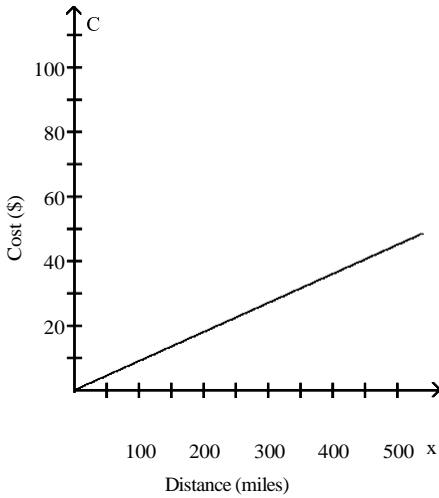

D)

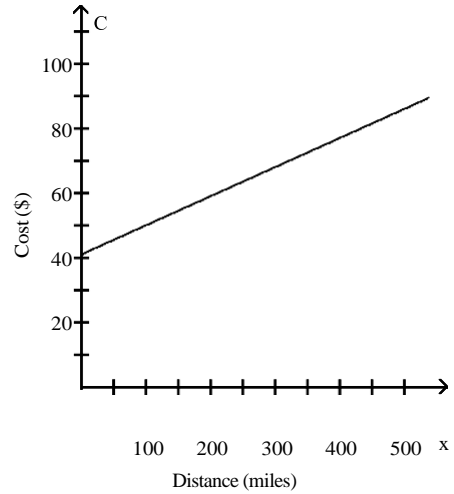

Answer: D

151) David recently switched to a long distance phone company which charges a monthly fee of \$5.45 plus \$0.06 per minute. Find a linear function that expresses the monthly bill B as a function of minutes used m .

A) $B(m) = 5.45m + 0.06$

B) $B(m) = 0.06m + 5.45m$

C) $B(m) = 5.51m$

D) $B(m) = 0.06m + 5.45$

Answer: D

152) David recently switched to a long distance phone company which charges a monthly fee of \$5.45 plus \$0.06 per minute. A linear function that expresses the monthly bill B as a function of minutes used m is

$B(m) = 0.06m + 5.45$. What are the independent and dependent variables?

A) The independent variable is 5.45, and the dependent variable is 0.06.

B) The independent variable is the customer, and the dependent variable is B .

C) The independent variable is m , and the dependent variable is B .

D) The independent variable is B , and the dependent variable is m .

Answer: C

153) David recently switched to a long distance phone company which charges a monthly fee of \$5.95 plus \$0.04 per minute. A linear function that expresses the monthly bill B as a function of minutes used m is

$B(m) = 0.04m + 0.04$. What is the implied domain of this linear function?

A) $[0, \infty)$

B) $[5.95, \infty)$

C) $(0, \infty)$

D) $[0, 595]$

Answer: A

154) David recently switched to a long distance phone company which charges a monthly fee of \$4.95 plus \$0.06 per minute. A linear function that expresses the monthly bill B as a function of minutes used m is

$B(m) = 0.06m + 4.95$. What is the monthly bill if 230 minutes were used for long distance phone calls?

A) \$18.75

B) \$16.55

C) \$142.95

D) \$13.80

Answer: A

155) David recently switched to a long distance phone company which charges a monthly fee of \$5.45 plus \$0.08 per minute. A linear function that expresses the monthly bill B as a function of minutes used m is

$B(m) = 0.08m + 5.45$. How many minutes were used for long distance if the long-distance phone bill was \$23.05?

A) 288 minutes

B) 200 minutes

C) 220 minutes

D) 231 minutes

Answer: C

156) David recently switched to a long distance phone company which charges a monthly fee of \$5.45 plus \$0.07 per minute. A linear function that expresses the monthly bill B as a function of minutes used m is

$B(m) = 0.07m + 5.45$. Graph the linear function. Use a domain of $0 \leq m \leq 300$.

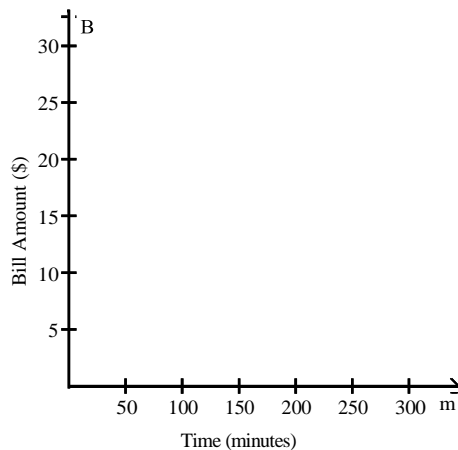

A)

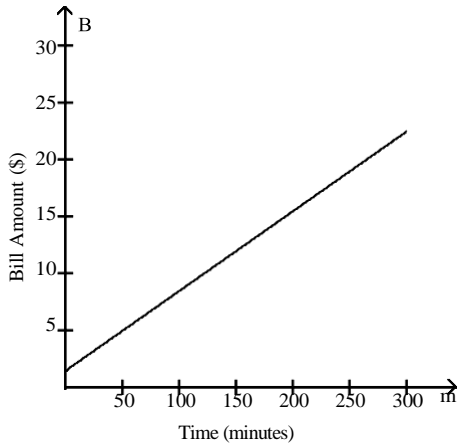

B)

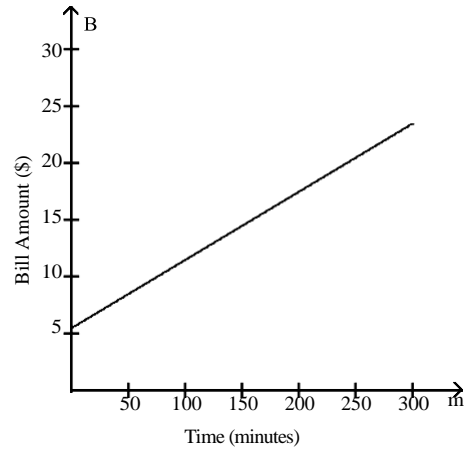

C)

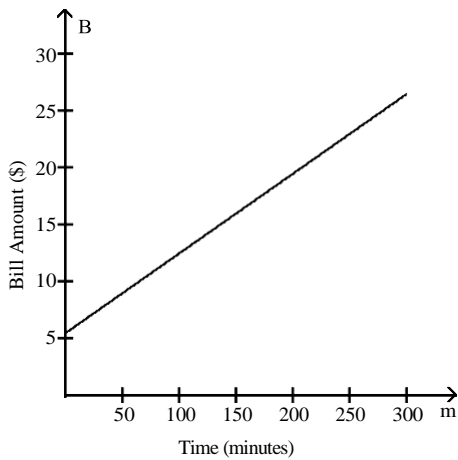

D)

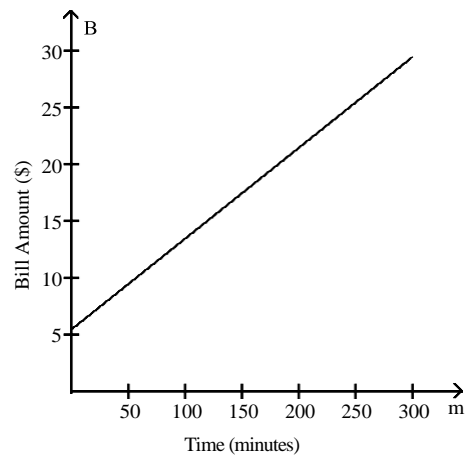

Answer: C

157) A company has just purchased a new computer for \$8000. The company chooses to depreciate the computer using the straight-line method over 8 years. Find a linear function that expresses the book value V of the computer as a function of its age x .

A) $V(x) = -1200x + 8000$

B) $V(x) = 1000x + 8000$

C) $V(x) = -8000x + 1000$

D) $V(x) = -1000x + 8000$

Answer: D

158) A company has just purchased a new computer for \$7000. The company chooses to depreciate the computer using the straight-line method over 7 years. A linear function that expresses the book value V of the computer as a function of its age x is $V(x) = -1000x + 7000$. What is the implied domain of this linear function?

A) $(-\infty, 7]$

B) $[0, 7]$

C) $[0, \infty)$

D) $[0, 7000]$

Answer: B

- 159) A company has just purchased a new computer for \$6300. The company chooses to depreciate the computer using the straight-line method over 7 years. A linear function that expresses the book value V of the computer as a function of its age x is $V(x) = -900x + 6300$. What are the intercepts of the graph of the linear function?
- A) The y-intercept is 7 and the x-intercept is 6300.
 - B) The y-intercept is 6300 and the x-intercept is 7.
 - C) The y-intercept is 6300 and the x-intercept is -900.
 - D) The y-intercept is 900 and the x-intercept is 7.

Answer: B

- 160) A company has just purchased a new computer for \$6000. The company chooses to depreciate the computer using the straight-line method over 6 years. A linear function that expresses the book value V of the computer as a function of its age x is $V(x) = -1000x + 6000$. What is the book value of the computer after 2 years?
- A) \$3900
 - B) \$5000
 - C) \$4100
 - D) \$4000

Answer: D

- 161) A company has just purchased a new computer for \$10,800. The company chooses to depreciate the computer using the straight-line method over 9 years. A linear function that expresses the book value V of the computer as a function of its age x is $V(x) = -1200x + 10,800$. When will the book value of the computer be \$6000?
- A) After 5 years
 - B) After 3 years
 - C) After 4 years
 - D) After 6 years

Answer: C

- 162) A company has just purchased a new computer for \$7520. The company chooses to depreciate the computer using the straight-line method over 8 years. A linear function that expresses the book value V of the computer as a function of its age x is $V(x) = -940x + 7520$. Graph the linear function V .

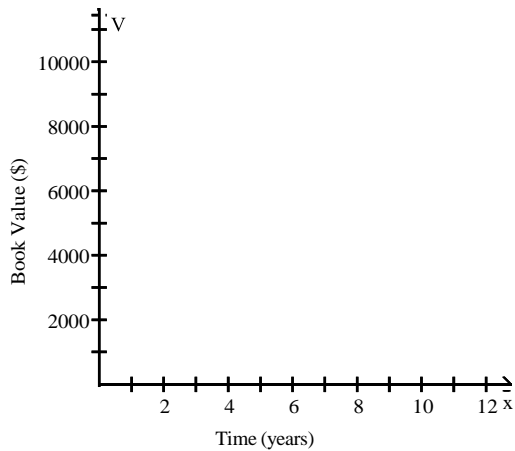

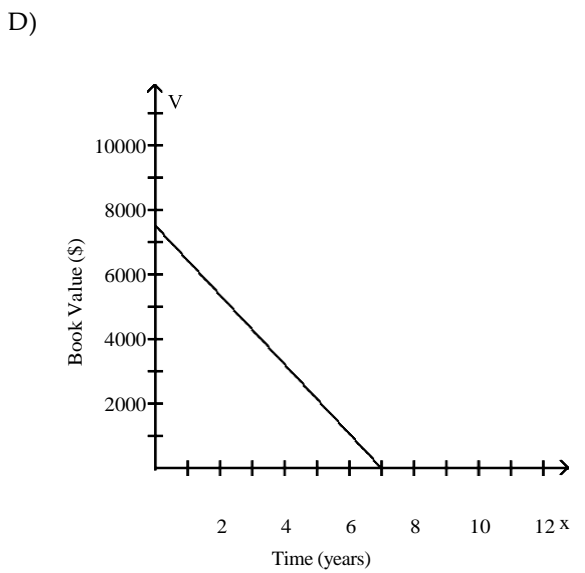
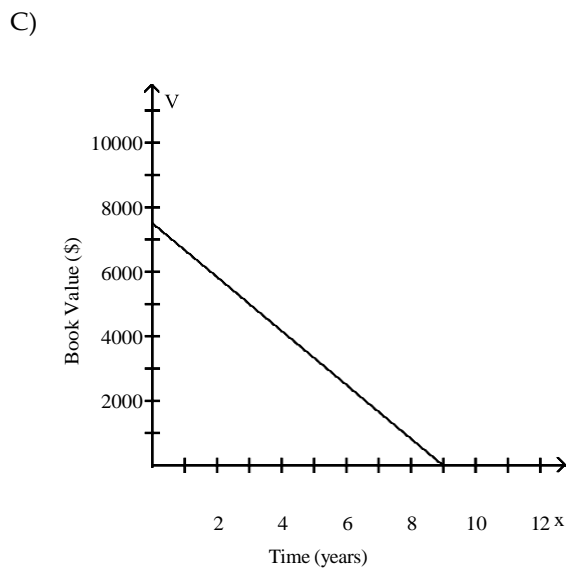
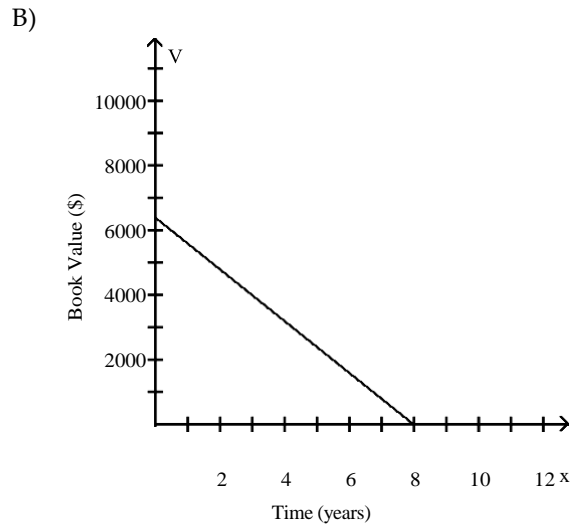
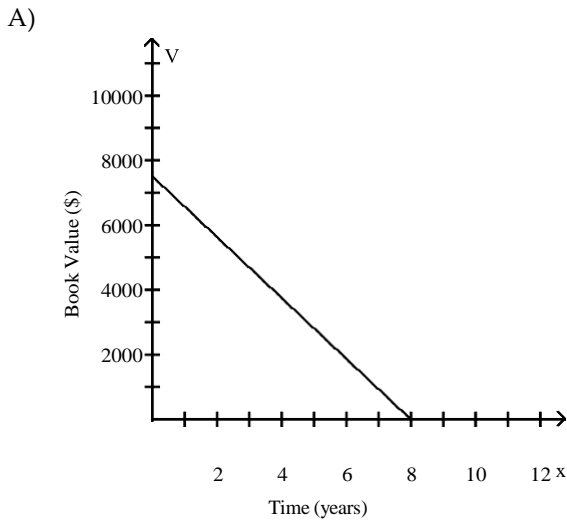

Answer: A

Determine whether the scatter diagram indicates that a linear relation may exist between the two variables. If a linear relation does exist, indicate whether the slope is positive or negative.

163)

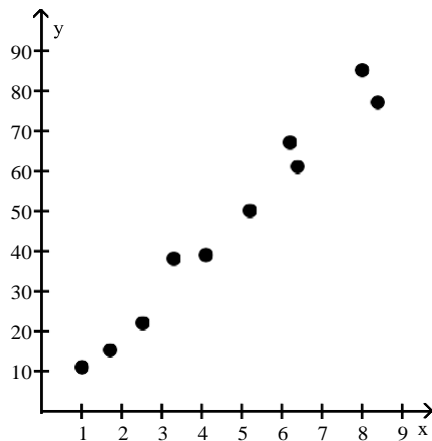

A) Linear with negative slope

B) Linear with positive slope

C) Nonlinear

Answer: B

164)

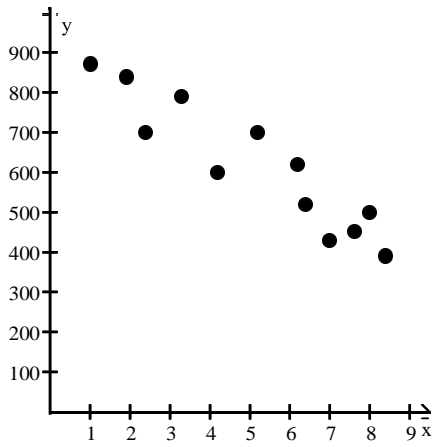

A) Nonlinear

B) Linear with positive slope

C) Linear with negative slope

Answer: C

165)

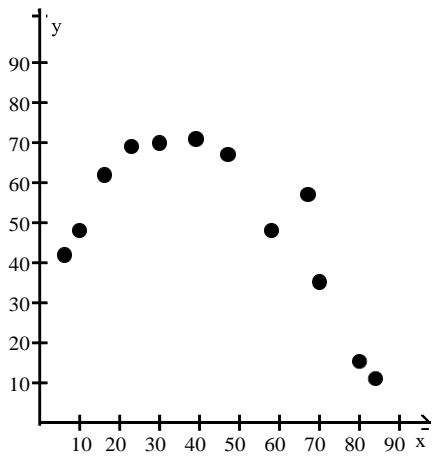

A) Nonlinear

B) Linear with negative slope

C) Linear with positive slope

Answer: A

166)

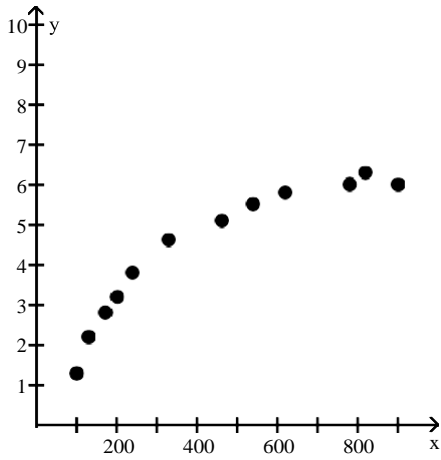

A) Linear with positive slope

B) Linear with negative slope

C) Nonlinear

Answer: C

167) Draw a scatter diagram of the given data. Find the equation of the line containing the points (1, 1.4) and (9, 4.4). Graph the line on the scatter diagram.

x	1	3	5	8	9
y	1.4	2.2	2.6	3.4	4.4

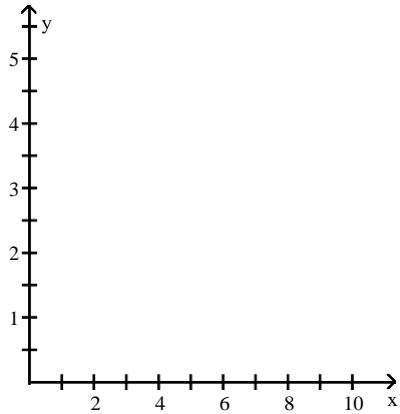

A)

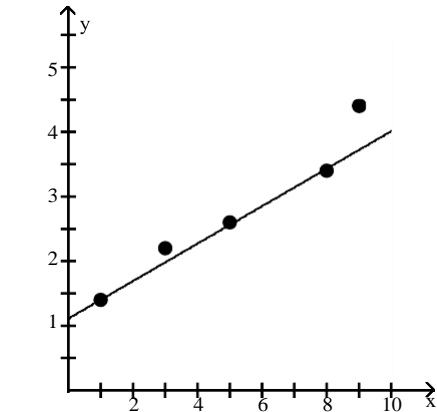

$$y = 0.29x + 1.11$$

B)

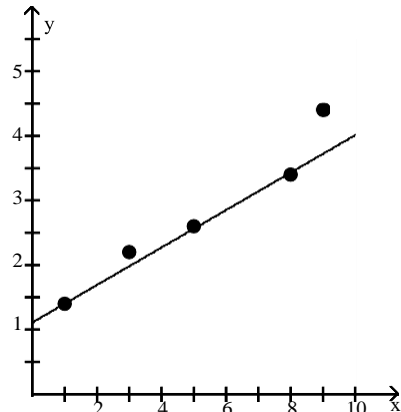

$$y = 0.34x + 1.01$$

C)

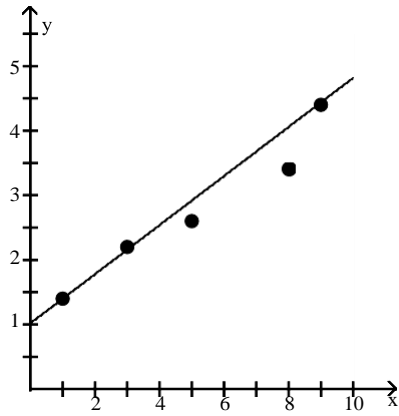

$$y = 0.38x + 1.03$$

Answer: C

D)

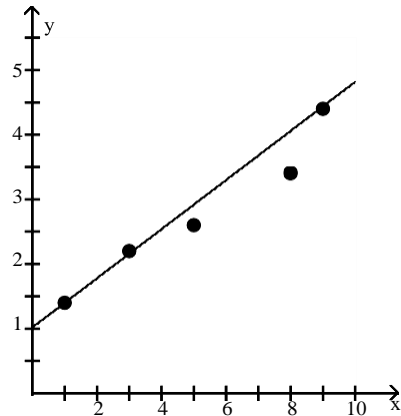

$$y = 0.41x + 1.03$$

168) Draw a scatter diagram of the given data. Find the equation of the line containing the points (2.1, 8.2) and (4.4, 2.9). Graph the line on the scatter diagram.

x	1.4	2.1	3.0	3.8	4.4
y	9.5	8.2	5.8	4.7	2.9

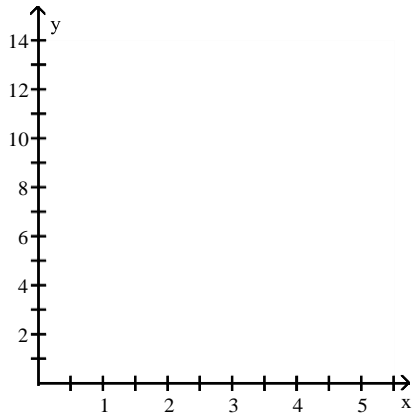

A)

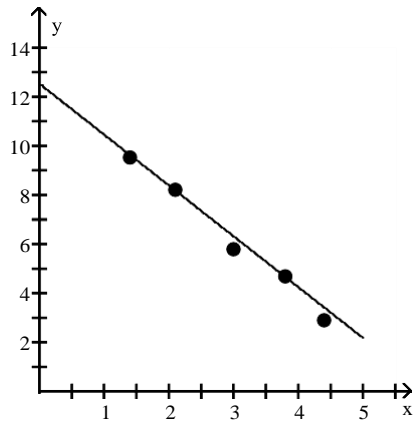

$$y = -2.53x + 13.54$$

B)

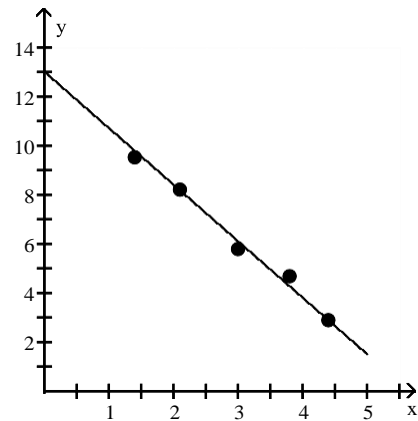

$$y = 2.3x + 13.04$$

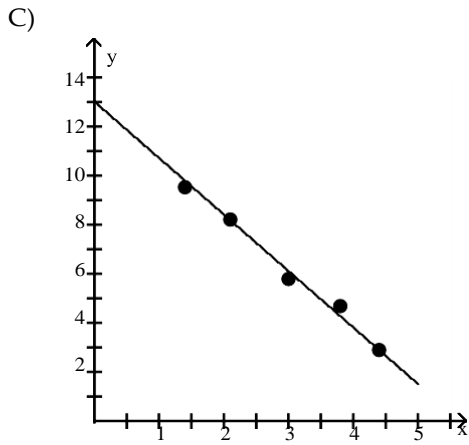

$$y = -2.3x + 13.04$$

Answer: C

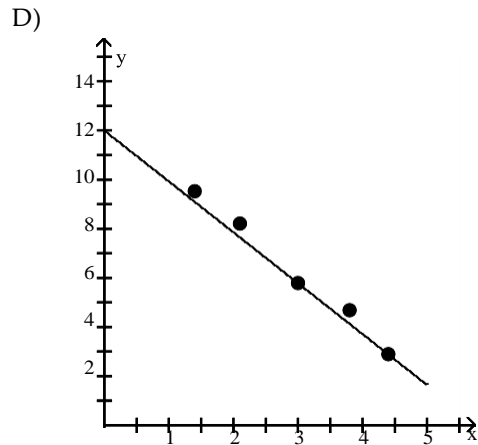

$$y = -2.07x + 12.01$$

Solve.

169) Find a linear function f such that $f(2) = 9$ and $f(5) = 21$.

A) $f(x) = -4x + 17$

B) $f(x) = -\frac{1}{4}x + \frac{19}{2}$

C) $f(x) = 4x + 1$

D) $f(x) = \frac{1}{4}x + \frac{17}{2}$

4 2

4 2

Answer: C

170) Find a linear function g such that $g(9) = -26$ and $g(7) = -20$.

A) $g(x) = -\frac{1}{3}x - 23$

B) $g(x) = 3x - 53$

C) $g(x) = -3x + 1$

D) $g(x) = \frac{1}{3}x - 29$

Answer: C

SHORT ANSWER. Write the word or phrase that best completes each statement or answers the question.

171) The following data represents the height (in inches) and weight (in pounds) of 9 randomly selected adults.

Height, x (in.)	Weight, y (lb)
65	142
72	189
61	111
68	157
74	195
66	172
62	126
70	179
67	185

Graph the data on a scatter diagram treating height as the independent variable. Find an equation of the line containing the points $(62, 126)$ and $(70, 179)$. Express the relationship using function notation. Graph the line on the scatter diagram. Interpret the slope of the line. Use the line to predict the weight of a person who is 70.7 inches tall. Round to the nearest pound.

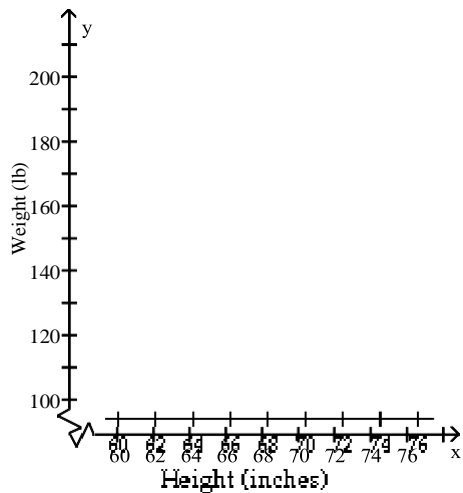

Answer:

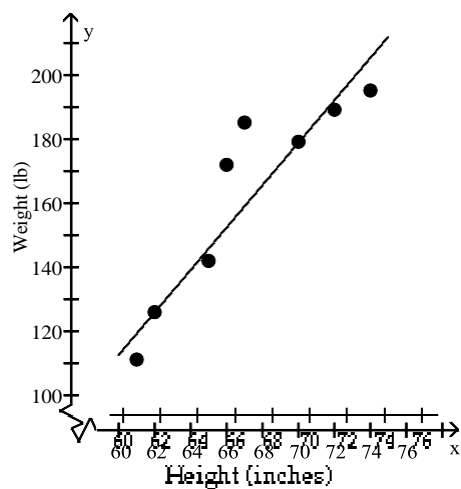

$$y = 6.625x - 284.75$$

$$W(h) = 6.625h - 284.75$$

If height is increased by one inch, then weight will increase by 6.625 pounds

184 lb

- 172) Ultraviolet radiation from the sun is thought to be one factor causing skin cancer. The amount of UV radiation a person receives is a function of the thickness of the earth's ozone layer which depends on the latitude of the area where the person lives. The following data represent the latitudes and melanoma rates for nine randomly selected areas in the United States. The melanoma rates refer to a three-year period.

Degrees North Latitude, x	Melanoma Rate (per 100,000), y
32.4	7.1
33.7	6.8
34.4	6.2
36.5	5.3
38.1	4.8
39.9	4.2
41.6	4.1
43.2	3.5
44.0	3.1

Graph the data on a scatter diagram treating latitude as the independent variable. Find an equation of the line

containing the points (32.4, 7.1) and (43.2, 3.5). Express the relationship using function notation. Graph the line on the scatter diagram. Interpret the slope of the line. Use the line to predict the melanoma rate of an area with a latitude of 37.3 degrees north.

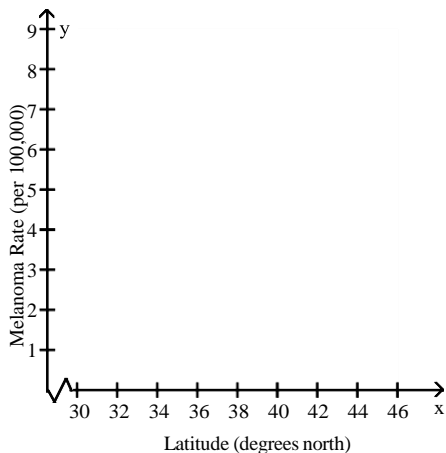

Answer:

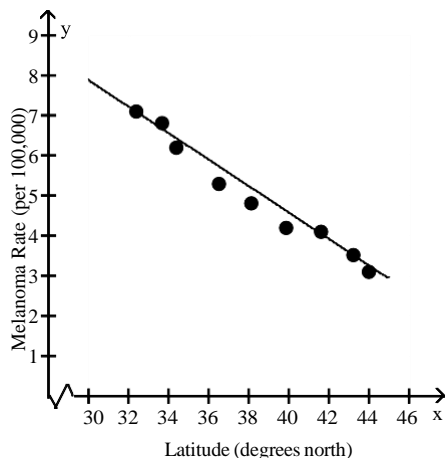

$$y = -0.33x + 17.9$$

$$M(l) = -0.33l + 17.9$$

If latitude is increased by one degree north, then melanoma rate will decrease by 0.33 per 100,000
5.47 per 100,000

MULTIPLE CHOICE. Choose the one alternative that best completes the statement or answers the question.

173) In the land of Taxalot, the function $T(x) = 0.16(x - 9600) + 750$ represents the tax bill T of a single person whose adjusted gross income is x dollars for incomes between 9600 and 28,600 inclusive. What is the implied domain of this linear function?

- A) (9600, 28,600) B) (9600, 28,600] C) [9600, 28,600] D) [9600, ∞)

Answer: C

174) In the land of Taxalot, the function $T(x) = 0.16(x - 8500) + 700$ represents the tax bill T of a single person whose adjusted gross income is x dollars for incomes between 8500 and 27,400 inclusive. What is a single filer's tax bill if adjusted gross income is \$18,400?

- A) \$2284 B) \$3644 C) \$1696 D) \$1584

Answer: A

- 175) In the land of Taxalot, the function $T(x) = 0.16(x - 8400) + 0.16$ represents the tax bill T of a single person whose adjusted gross income is x dollars for incomes between 8400 and 26,800 inclusive. Which variable is independent and which is dependent?
- A) The independent variable is gross income; the dependent variable is adjusted gross income
 - B) The independent variable is T ; the dependent variable is x
 - C) The independent variable is x ; the dependent variable is 8400
 - D) The independent variable is x ; the dependent variable is T

Answer: D

- 176) In the land of Taxalot, the function $T(x) = 0.18(x - 9700) + 750$ represents the tax bill T of a single person whose adjusted gross income is x dollars for incomes between 9700 and 27,600 inclusive. Graph the linear function over its domain.



A)

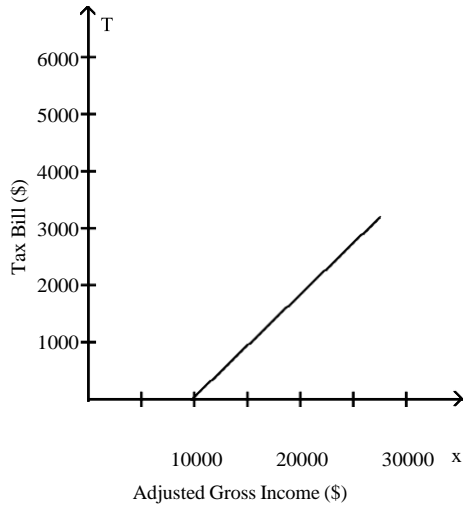

B)

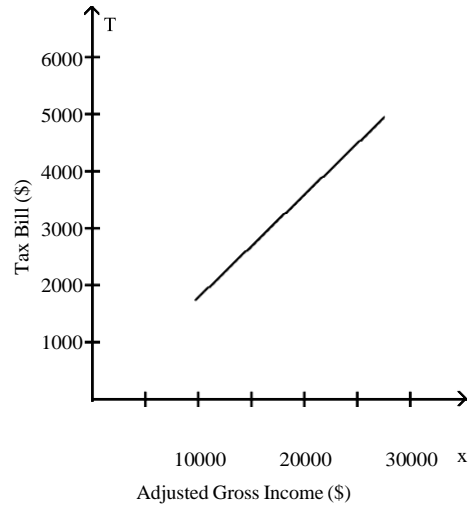

C)

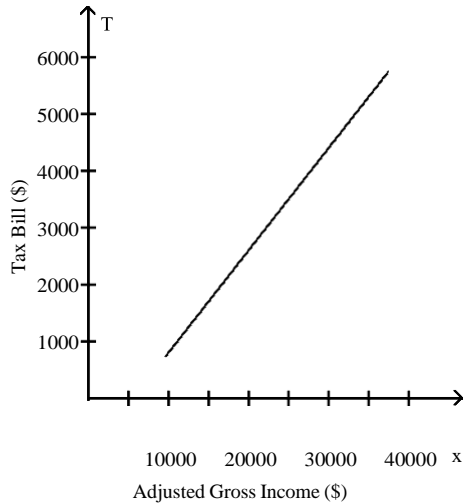

D)

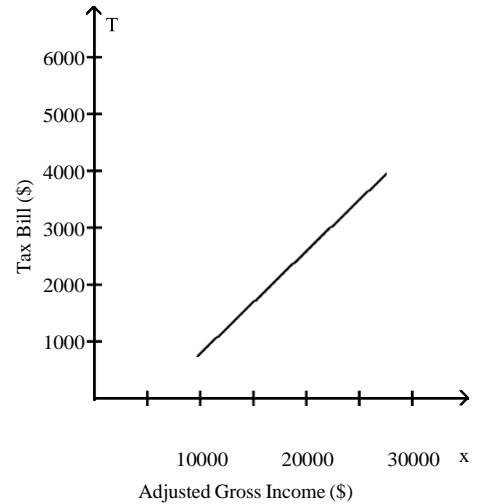

Answer: D

- 177) In the land of Taxalot, the function $T(x) = 0.21(x - 9200) + 760$ represents the tax bill T of a single person whose adjusted gross income is x dollars for incomes between 9200 and 30,200 inclusive. What is a single filer's tax bill if adjusted gross income if their tax bill is \$1558?
- A) \$13,000 B) \$12,900 C) \$14,000 D) \$13,200

Answer: A

- 178) Mike works on commission selling electronic equipment. The linear function $I(s) = 0.01s + 22,300$ describes his annual income I when his total sales for the year are s . What is the implied domain of this linear function?
- A) $(0, \infty)$ B) $[22,300, \infty)$ C) $[0, \infty)$ D) $[0, 22,300]$

Answer: C

- 179) Mike works on commission selling electronic equipment. The linear function $I(s) = 0.01s + 26,100$ describes his annual income I when his total sales for the year are s . What is $I(0)$. What does this result mean?
- A) \$26,100; this is Mike's annual salary if his total sales for the year are zero
 B) \$26,100.01; this is the increase in Mike's annual salary for each \$1000 increase in his sales
 C) \$26,100.01; this is Mike's annual salary if his total sales for the year are zero
 D) \$26,100; this is the amount of sales for which Mike's annual salary is zero

Answer: A

- 180) Mike works on commission selling electronic equipment. The linear function $I(s) = 0.04s + 26,100$ describes his annual income I when his total sales for the year are s . What is Mike's annual salary if he sells \$550,000 in electronic equipment for the year?
- A) \$48,100 B) \$28,300 C) \$246,100 D) \$23,044

Answer: A

181) Mike works on commission selling electronic equipment. The linear function $I(s) = 0.06s + 20,400$ describes his annual income I when his total sales for the year are s . Graph the linear function.

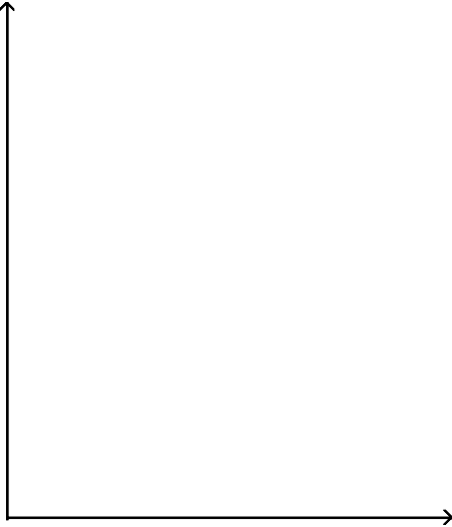

A)

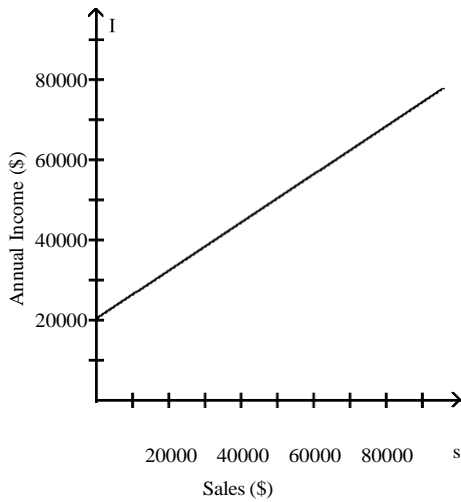

B)

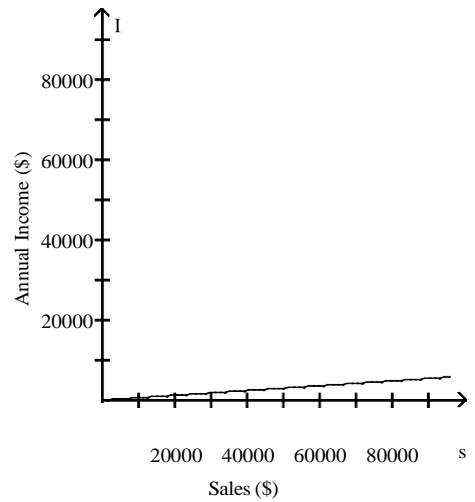

C)

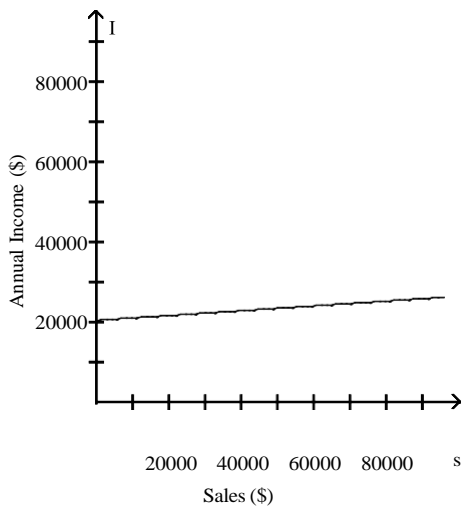

D)

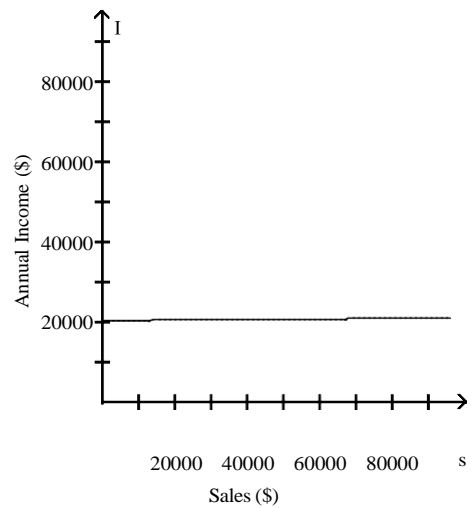

Answer: C

- 182) Mike works on commission selling electronic equipment. The linear function $I(s) = 0.05s + 23,700$ describes his annual income I when his total sales for the year are s . At what level of sales will Mike's income be \$41,700?
- A) \$36,000 B) \$371,000 C) \$360,000 D) \$3,600,000

Answer: C

- 183) A multiple birth is any birth with 2 or more children born. The birth rate is the number of births per 1000 women. In one country, the birth rate B of multiple births as a function of age a is given by the function $B(a) = 1.68a - 14.01$ for $15 \leq a \leq 46$. What are the independent and dependent variables?

- A) The independent variable is multiple birth rate, B ; the dependent variable is age, a
 B) The independent variable is birth rate; the dependent variable is multiple birth rate
 C) The independent variable is age, a ; the dependent variable is the number of children born
 D) The independent variable is age, a ; the dependent variable is multiple birth rate, B

Answer: D

- 184) A multiple birth is any birth with 2 or more children born. The birth rate is the number of births per 1000 women. In one country, the birth rate B of multiple births as a function of age a is given by the function $B(a) = 1.75a - 14.32$ for $15 \leq a \leq 45$. What is the domain of the linear function?

- A) (15, 45) B) [15, 45] C) [15, ∞) D) [2, ∞)

Answer: B

- 185) A multiple birth is any birth with 2 or more children born. The birth rate is the number of births per 1000 women. In one country, the birth rate B of multiple births as a function of age a is given by the function $B(a) = 1.77a - 14.37$ for $15 \leq a \leq 45$. What is the multiple birth rate of women who are 21 years of age according to the model?

- A) 37.17 B) 51.54 C) 11.74 D) 22.8

Answer: D

- 186) A multiple birth is any birth with 2 or more children born. The birth rate is the number of births per 1000 women. In one country, the birth rate B of multiple births as a function of age a is given by the function $B(a) = 1.79a - 14.38$ for $15 \leq a \leq 44$. Graph the linear function over its domain.

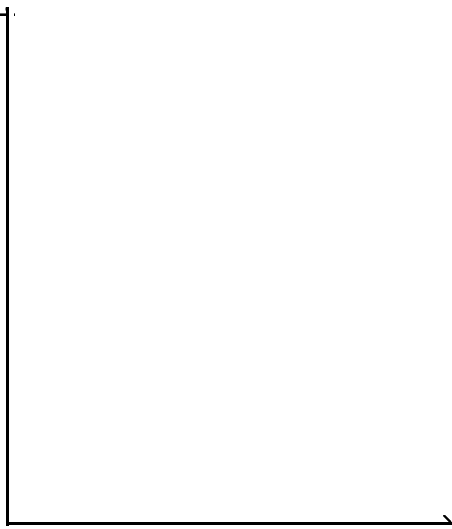

A)

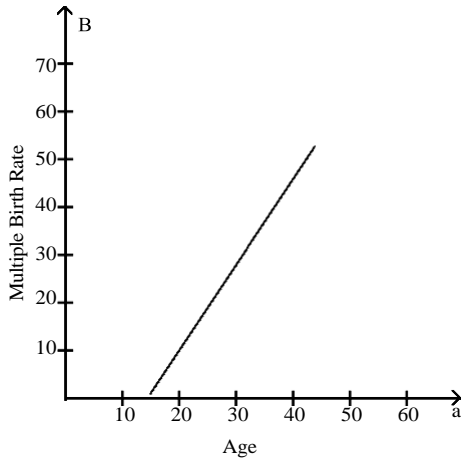

B)

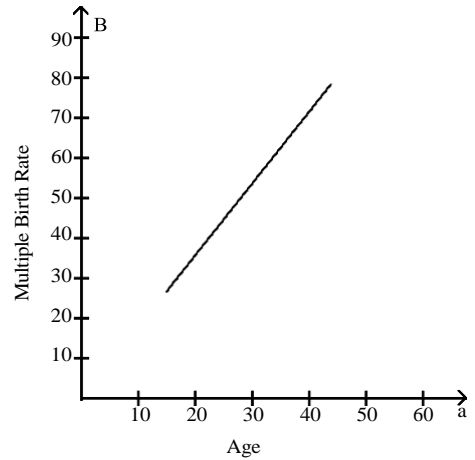

C)

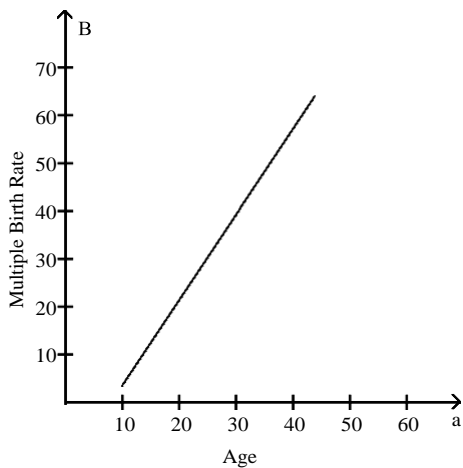

D)

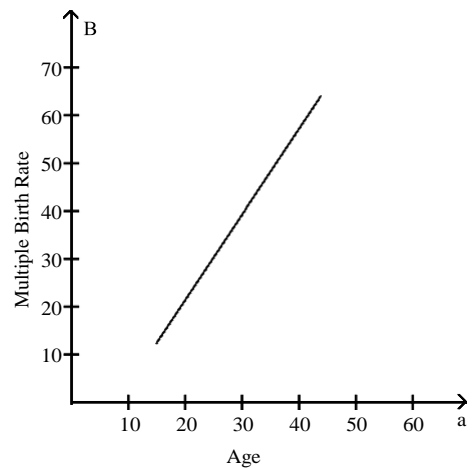

Answer: D

187) A multiple birth is any birth with 2 or more children born. The birth rate is the number of births per 1000 women. In one country, the birth rate B of multiple births as a function of age a is given by the function $B(a) = 1.67a - 14.75$ for $15 \leq a \leq 45$. What is age of women whose multiple birth rate is 43.7?

A) 40

B) 35

C) 37

D) 32

Answer: B

188) The price of commodities, like pork bellies, is determined by supply and demand. Thus, the price of pork bellies is a function of the number of pounds of pork bellies produced. The price of a pound of pork bellies can be estimated by the function

$$f(Q) = -0.000003Q + 0.85, \quad 10,000 \leq Q \leq 80,000$$

where $f(Q)$ is the price of a pound of pork bellies and Q is the annual number of pounds of pork bellies produced.

i) Construct a graph showing the relationship between the number of pounds of pork bellies produced and the price of a pound of pork bellies.

ii) Estimate the cost of a pound of pork bellies if 70,000 pounds of pork bellies are produced in a given year.

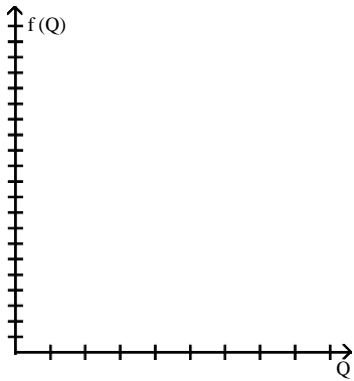

A) i)

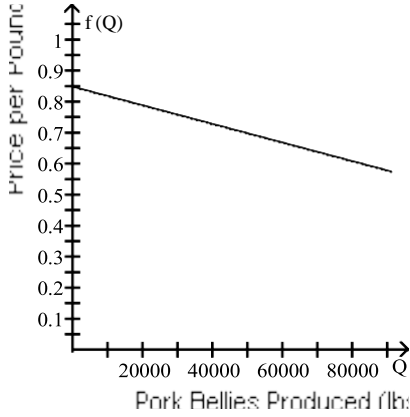

ii) \$1.06 per pound

C) i)

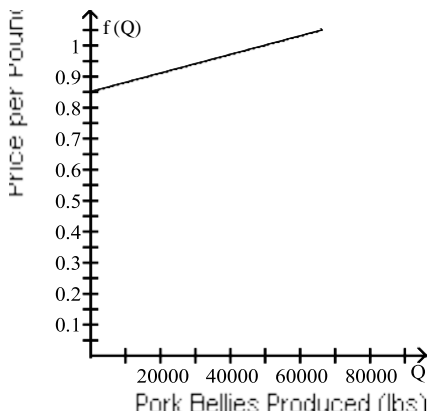

ii) \$1.06 per pound

Answer: B

B) i)

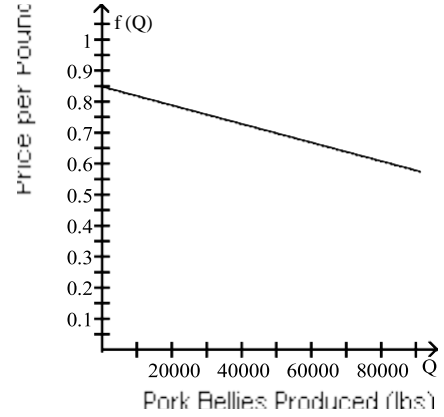

ii) \$0.64 per pound

D) i)

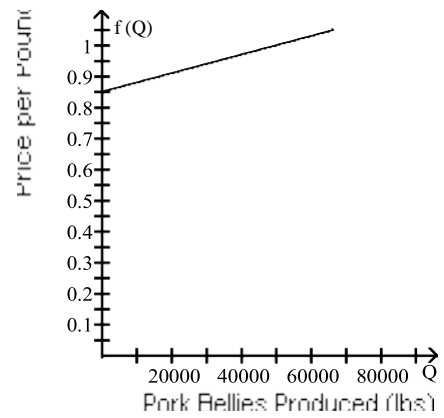

ii) \$0.64 per pound

Find the intersection of the sets.

189) $\{-4, -2, 1, 6\} \cap \{1, 6, 7\}$

A) $\{-4, -2, 1, 6\}$

B) $\{-4, -2, 1, 6, 7\}$

C) $\{1, 6\}$

D) $\{1, 6, 7\}$

Answer: C

- 190) $\{-5, -1, 2, 6\} \cap \{-4, 1, 5, 9\}$
 A) $\{-5, -4, -1, 1, 2, 5, 6, 9\}$
 C) $\{-1, 1, 2\}$

- B) \emptyset
 D) $\{1\}$

Answer: B

Find the union of the sets.

- 191) $\{-5, -2, 2, 5\} \cup \{2, 5, 8\}$
 A) $\{2, 5, 8\}$

B) $\{-5, -2, 2, 5, 8\}$

C) $\{-5, -2, 2, 5\}$

D) $\{2, 5\}$

Answer: B

- 192) $\{-6, -2, 2, 7\} \cup \{-4, 0, 4, 9\}$
 A) $\{-2, 0, 2\}$
 C) $\{0\}$

- B) $\{-6, -4, -2, 0, 2, 4, 7, 9\}$
 D) \emptyset

Answer: B

Use the graph of the inequality to find the set.

- 193) $A = \{x \mid x < 5\}$, $B = \{x \mid x > -2\}$

Find $A \cap B$.

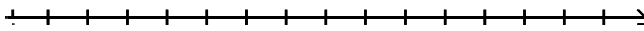
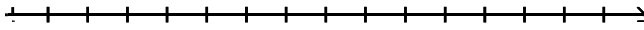

- A) $\{x \mid -2 < x < 5\}$; $(-2, 5)$

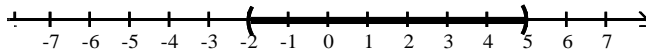

- B) $\{x \mid x > -2\}$; $(-2, \infty)$

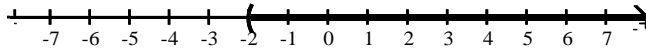

- C) $\{x \mid 6 < x < 3\}$; $(-6, 3)$

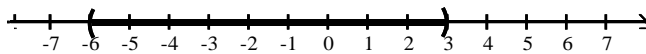

- D) $\{x \mid x < 5\}$; $(-\infty, 5)$

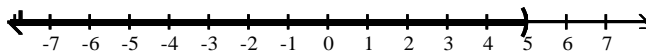

Answer: A

194) $A = \{x | x < -5\}$, $B = \{x | x > 4\}$

Find $A \cap B$.

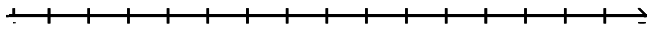
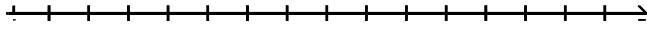

A) $\{x | -5 < x < 4\}$; $(-5, 4)$

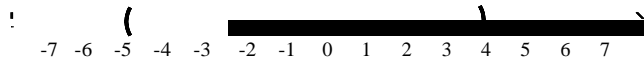

B) $\{x | x > 4\}$; $(4, \infty)$

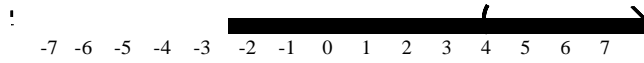

C) $\{x | x < 5\}$; $(-\infty, -5)$

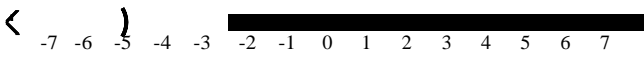

D) $\{ \}; \emptyset$

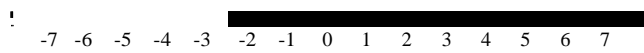

Answer: D

195) $A = \{x | x < 3\}$, $B = \{x | x > -2\}$

Find $A \cup B$.

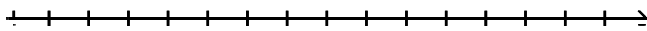
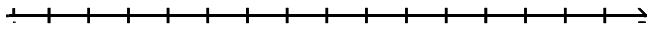

A) $\{x | -\infty < x < \infty\}$; $(-\infty, \infty)$

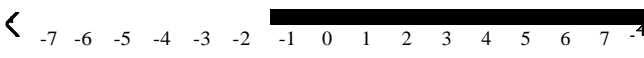

B) $\{x | -2 < x < 3\}$; $(-2, 3)$

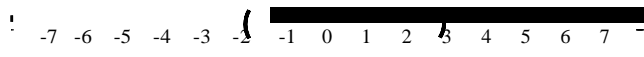

C) $\{x | x > -2\}$; $(-2, \infty)$

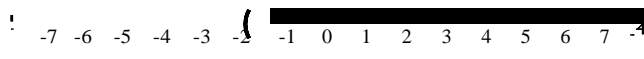

D) $\{x | x < 3\}$; $(-\infty, 3)$

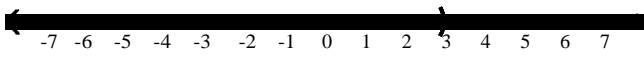

Answer: A

196) $A = \{x \mid x < -1\}$, $B = \{x \mid x > 1\}$

Find $A \cup B$.

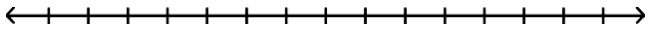
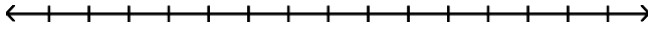

A) $\{x \mid -1 < x < 1\}$; $(-1, 1)$

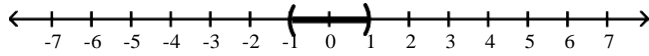

B) $\{x \mid x < -1 \text{ or } x > 1\}$; $(-\infty, -1) \cup (1, \infty)$

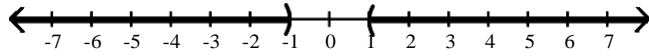

C) $\{ \}$; \emptyset

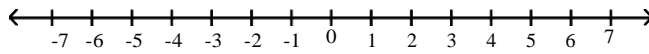

D) $\{x \mid -\infty < x < \infty\}$; $(-\infty, \infty)$

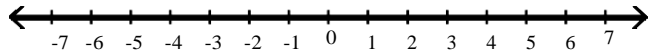

Answer: B

Solve the compound inequality. Express the solution using interval notation. Graph the solution set.

197) $x \leq 5$ and $x \geq -3$

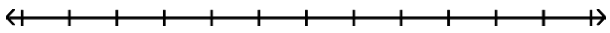

A) $(-\infty, -3] \cup [5, \infty)$

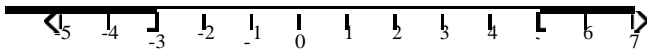

B) $(-3, 5)$

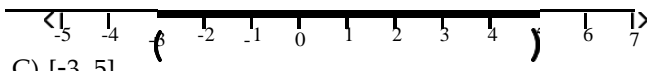

C) $[-3, 5]$

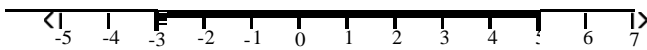

D) \emptyset

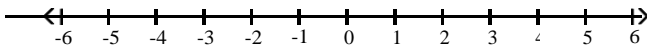

Answer: C

198) $x \leq 3$ and $x \leq -2$

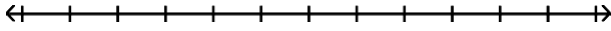

A) $(-\infty, -2]$

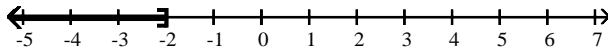

B) $[-2, 3]$

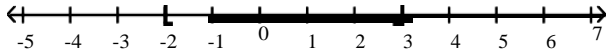

C) $(-\infty, -2] \cup [3, \infty)$

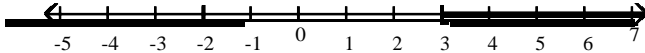

D) $[-2, \infty)$

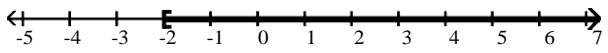

Answer: A

199) $4x < 20$ and $x + 4 > 6$

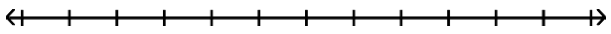

A) $[2, 5]$

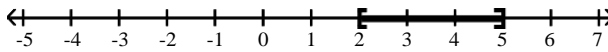

B) $(2, 5)$

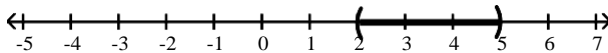

C) $(-\infty, 2) \cup (5, \infty)$

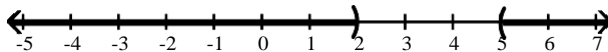

D) \emptyset

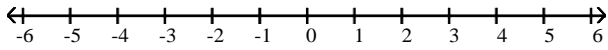

Answer: B

200) $-8x > -40$ and $x + 8 > 7$

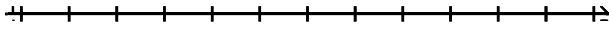

A) $(5, \infty)$

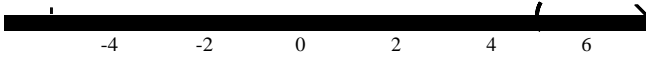

B) $(-1, 5)$

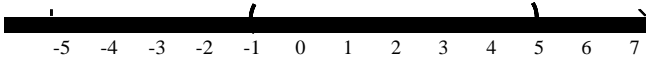

C) $(-\infty, -1) \cup (5, \infty)$

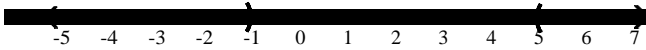

D) \emptyset

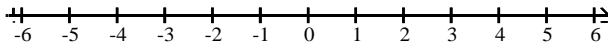

Answer: B

201) $x + 6 < 5$ and $-6x < -30$

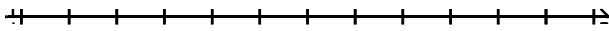

A) $(-\infty, -1) \cup (5, \infty)$

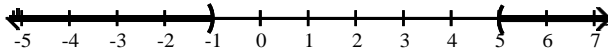

B) $(-\infty, -1)$

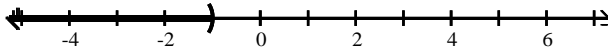

C) $(-1, 5)$

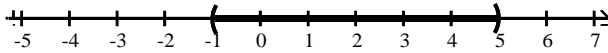

D) \emptyset

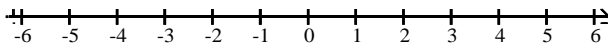

Answer: D

202) $-4x < -20$ and $x + 4 > 5$

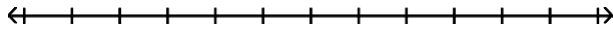

A) $(1, 5)$

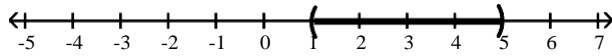

B) $(5, \infty)$

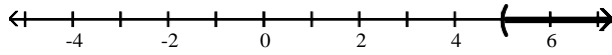

C) $(-\infty, 1) \cup (5, \infty)$

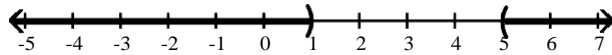

D) \emptyset

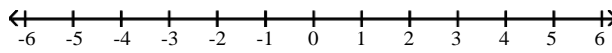

Answer: B

203) $12 < 3x \leq 15$

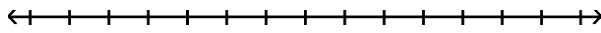

A) $(-5, -4]$

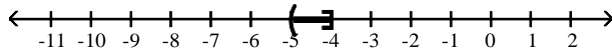

B) $[4, 5)$

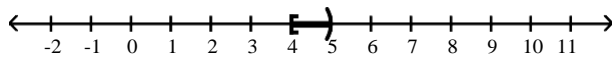

C) $[-5, -4)$

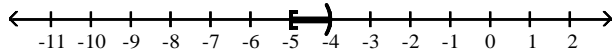

D) $(4, 5]$

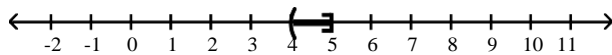

Answer: D

204) $6 \leq 3t - 3 \leq 18$

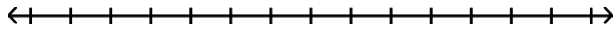

A) (3, 7)

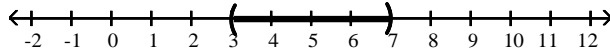

B) [-7, -3]

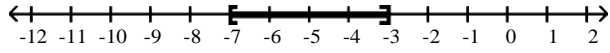

C) (-7, -3)

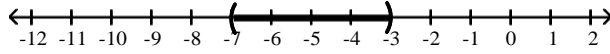

D) [3, 7]

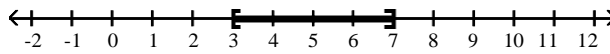

Answer: D

205) $-15 \leq -3c + 3 < -9$

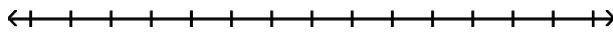

A) (-6, -4]

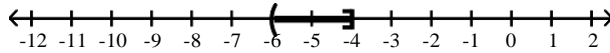

B) [4, 6)

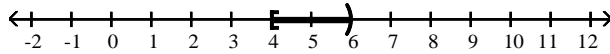

C) [-6, -4)

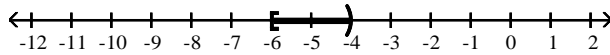

D) (4, 6]

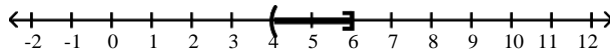

Answer: D

206) $-26 \leq -5z + 4 \leq -16$

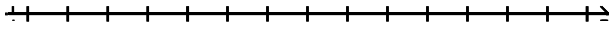

A) (4, 6)

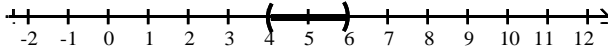

B) [4, 6]

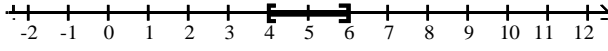

C) [-6, -4]

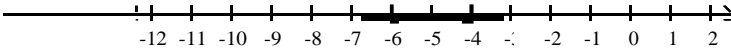

D) (-6, -4)

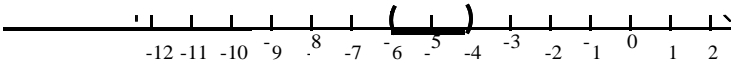

Answer: B

207) $0 \leq \frac{3}{2}x - 3 < 12$

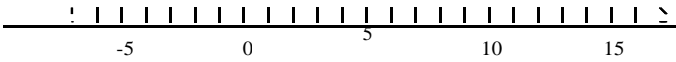

A) (2, 10]

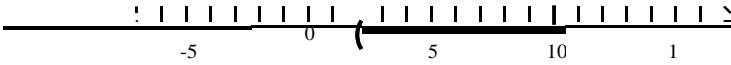

B) (2, 3]

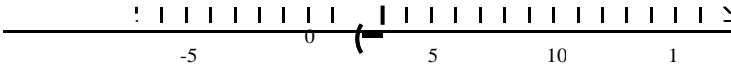

C) [2, 10)



D) [2, 3)

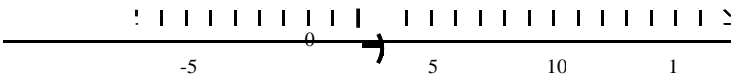

Answer: C

$$208) 0 \leq \frac{2x+1}{2} < 3$$

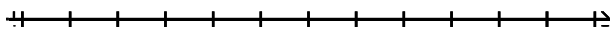

A) $\left[-\frac{1}{2}, \frac{5}{2}\right]$

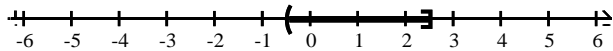

B) $\left[-\frac{1}{2}, \frac{5}{2}\right]$

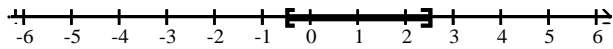

C) $\left(-\frac{1}{2}, \frac{5}{2}\right)$

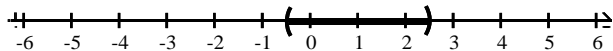

D) $\left[-\frac{1}{2}, \frac{5}{2}\right)$

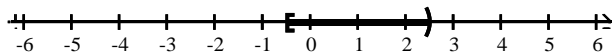

Answer: D

$$209) -\frac{1}{3} \leq \frac{7x-1}{9} < \frac{1}{3}$$

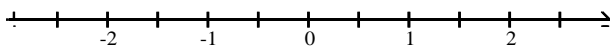

A) $\left[-\frac{2}{7}, \frac{4}{7}\right]$

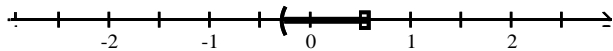

B) $\left[-\frac{2}{7}, \frac{4}{7}\right)$

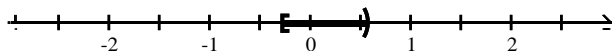

C) $\left(-\frac{2}{7}, \frac{4}{7}\right)$

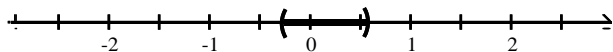

D) $\left[-\frac{8}{21}, \frac{10}{21}\right)$

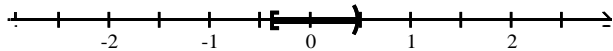

Answer: B

210) $x \leq 2$ or $x \geq 8$

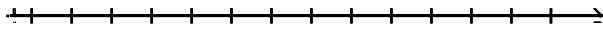

A) $(-\infty, 2] \cup [8, \infty)$

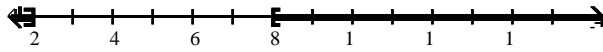

B) $(-2, 8)$

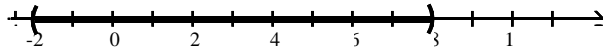

C) $(2, 8)$

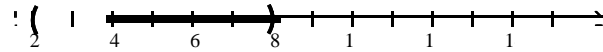

D) $[-8, -2]$

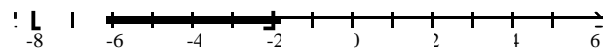

Answer: A

211) $x < 5$ or $x < 7$

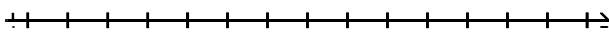

A) $(-\infty, 5) \cup (7, \infty)$

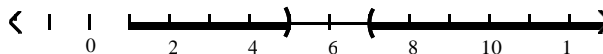

B) $(5, 7)$

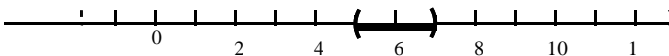

C) $(-\infty, 7)$

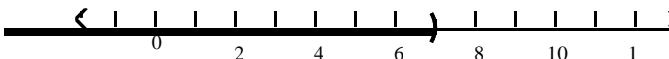

D) $(5, \infty)$

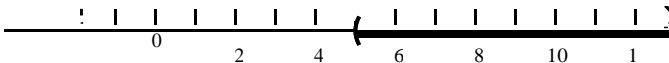

Answer: C

212) $x > 3$ or $x < 3$

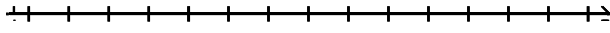

A) $(-\infty, 3)$

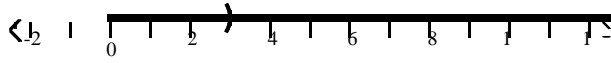

B) $(3, 3)$

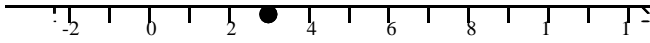

C) $(3, \infty)$

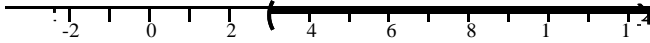

D) $(-\infty, 3) \cup (3, \infty)$

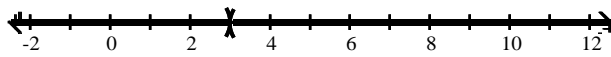

Answer: D

213) $9x - 6 < 3x$ or $-2x \leq -6$

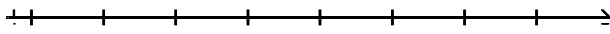

A) $(-\infty, 1) \cup [3, \infty)$

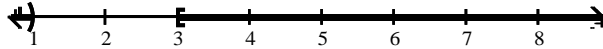

B) $[1, 3]$

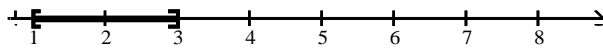

C) $(1, 3)$

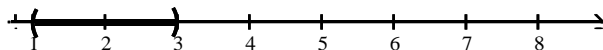

D) \emptyset

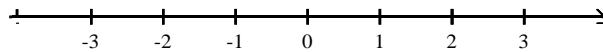

Answer: A

214) $-7x + 1 \geq 15$ or $5x + 3 \geq -17$

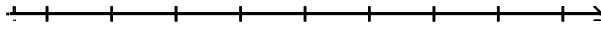

A) $[-4, \infty)$

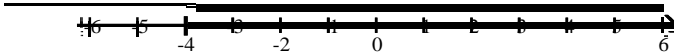

B) $[-4, -2]$

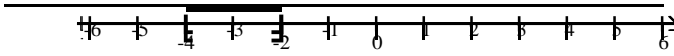

C) $[-2, \infty)$

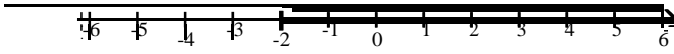

D) $(-\infty, \infty)$

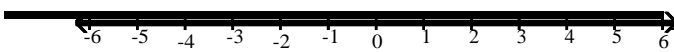

Answer: D

Solve the problem.

215) The daily number of visitors v to an amusement park was always at least 862 but never more than 1108. Express this as an inequality.

- A) $v \leq 862$ or $v \geq 1108$ B) $862 \leq v \leq 1108$ C) $862 < v < 1108$ D) $v < 862$ or $v > 1108$

Answer: B

216) The formula $C = 2x + 20$ represents the estimated future cost of yearly attendance at State University, where C is the cost in thousands of dollars x years after 2002. Use a compound inequality to determine when the attendance costs will range from 34 to 42 thousand dollars.

- A) From 2008 to 2012 B) From 2010 to 2012 C) From 2010 to 2014 D) From 2009 to 2013

Answer: D

217) The formula for converting Fahrenheit temperatures to Celsius temperatures is $C = \frac{5}{9}(F - 32)$. Use this formula

to solve the problem. In a certain city, the average temperature ranges from -11° to 30° Celsius. Find an inequality that represents the range of Fahrenheit temperatures. If necessary, round to the nearest tenth of a degree.

- A) $-19.8^\circ \leq F \leq 54^\circ$ B) $-51.8^\circ \leq F \leq 22^\circ$ C) $12.2^\circ \leq F \leq 86^\circ$ D) $25.9^\circ \leq F \leq 48.7^\circ$

Answer: C

218) Cindy has scores of 72, 84, 84, and 88 on her biology tests. Use a compound inequality to find the range of scores she can make on her final exam to receive a C in the course. The final exam counts as two tests, and a C is received if the course average is between 70 and 79.

- A) $70 \leq \text{final score} \leq 79$ B) $92 \leq \text{final score} \leq 146$
 C) $11 \leq \text{final score} \leq 33.5$ D) $46 \leq \text{final score} \leq 73$

Answer: D

219) At one point the exchange equation for converting American dollars into Japanese yen was $Y = 129(d - 4)$ where d is the number of American dollars, Y is the number of yen, and \$4 is a one-time bank fee charged for currency conversions. Use this equation to solve the following problem.

Ariel is traveling to Japan for 3 weeks and has been advised to have between 19,000 and 30,000 yen for spending money for each week he is there. Write an inequality that represents the number of American dollars he will need to bring to the bank to exchange money for this 3-week period.

- A) $\$441.89 \leq d \leq \697.71 B) $\$441.95 \leq d \leq \697.77
C) $\$445.86 \leq d \leq \701.67 D) $\$453.86 \leq d \leq \709.67

Answer: C

220) The formula for converting Celsius temperature, C , to Fahrenheit temperature, F , is

$$F = \frac{9}{5}C + 32.$$

If Fahrenheit temperature ranges from 167° to 257° , inclusive, what is the range for the Celsius temperature?

- A) $75 \leq C \leq 125$ B) $333 < C < 495$
C) $75 < C < 125$ D) $333 \leq C \leq 495$

Answer: A

221) Parts for an automobile repair cost \$324. The mechanic charges \$27 per hour. If you receive an estimate for at least \$378 and at most \$459 for fixing the car, what is the time interval that the mechanic will be working on the job?

- A) $1 \leq t \leq 2$ B) $1 \leq t \leq 5$ C) $14 \leq t \leq 17$ D) $2 \leq t \leq 5$

Answer: D

Solve the absolute value equation.

222) $|x| = 5$

- A) $\{5, -5\}$ B) $\{25\}$ C) $\{5\}$ D) $\{-5\}$

Answer: A

223) $|12x| = 15.6$

- A) $\{-1.3\}$ B) $\{1.3, -1.3\}$ C) $\{0, 1.3, -1.3\}$ D) $\{1.3\}$

Answer: B

224) $|x - 9| = 4$

- A) $\{5, 13\}$ B) $\{-13\}$ C) $\{-5, 13\}$ D) \emptyset

Answer: A

225) $|x| + 3 = 12$

- A) $\{-9\}$ B) $\{15\}$ C) $\{9\}$ D) $\{-9, 9\}$

Answer: D

226) $|7x + 2| = 8$

- A) $\left\{3, -5\right\}$ B) $\left\{-\frac{6}{7}, \frac{10}{7}\right\}$ C) $\left\{\frac{6}{7}, -\frac{10}{7}\right\}$ D) \emptyset

Answer: C

227) $\left|\frac{9x + 36}{4}\right| = 9$

- A) $\{8, 0\}$ B) $\{-8, 8\}$ C) $\{-8, 0\}$ D) \emptyset

Answer: C

228) $|5x| + 2 = 9$

A) $\{7, -7\}$

B) $\left\{\frac{5}{7}, -\frac{5}{7}\right\}$

C) $\left\{\frac{7}{5}, -\frac{7}{5}\right\}$

D) \emptyset

Answer: C

229) $|9x| = 0$

A) $\{9\}$

B) $\left\{\frac{1}{9}\right\}$

C) $\{9, -9\}$

D) $\{0\}$

Answer: D

230) $|5x + 6| + 6 = 11$

A) $\left\{-\frac{1}{6}, -\frac{11}{6}\right\}$

B) $\left\{-\frac{1}{5}, -\frac{11}{5}\right\}$

C) $\left\{\frac{1}{5}, \frac{11}{5}\right\}$

D) \emptyset

Answer: B

231) $|3x + 9| + 7 = 3$

A) $\left\{-\frac{5}{9}, -\frac{13}{9}\right\}$

B) $\left\{\frac{5}{3}, \frac{13}{3}\right\}$

C) $\left\{-\frac{5}{3}, -\frac{13}{3}\right\}$

D) \emptyset

Answer: D

232) $|6x - 11| = 0$

A) $\left\{\frac{11}{6}\right\}$

B) $\left\{\frac{11}{6}\right\}$

C) $\left\{\frac{11}{6}, -\frac{11}{6}\right\}$

D) \emptyset

Answer: B

233) $|7x + 4| = |x + 6|$

A) $\left\{\frac{1}{3}, \frac{1}{4}\right\}$

B) $\left\{-\frac{1}{3}, \frac{5}{4}\right\}$

C) $\left\{\frac{1}{3}, -\frac{5}{4}\right\}$

D) \emptyset

Answer: C

234) $|x + 3| = |9 - x|$

A) $\left\{-\frac{1}{3}\right\}$

B) $\{6\}$

C) $\{3\}$

D) \emptyset

Answer: C

235) $|-6x + 6| = |3 + 2x|$

A) $\left\{\frac{3}{8}, -\frac{9}{4}\right\}$

B) $\frac{3}{8}$
 $\{8\}$

C) $\left\{\frac{3}{8}, \frac{9}{4}\right\}$

D) \emptyset

Answer: C

236) $\left|\frac{7x+3}{3}\right| = |-4|$

A) $\left\{\frac{15}{7}\right\}$

$$\text{B) } \frac{9}{-15},$$

$$\text{C) } \frac{-9}{2}$$

$$\text{D) } \left\{ \frac{}{7} \quad \frac{}{7} \right\}$$

$$\left\{ \frac{}{7} \right\}$$

Answer: B

Solve the inequality. Graph the solution set, and state the solution set in interval notation.

237) $|x| \leq 2$

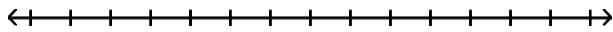

A) $(-\infty, -2] \cup [2, \infty)$

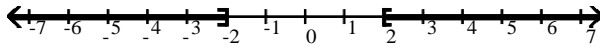

B) $(-\infty, 2]$

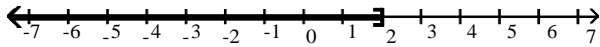

C) $(-2, 2)$

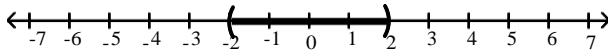

D) $[-2, 2]$

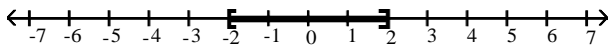

Answer: D

238) $|x| < 2$

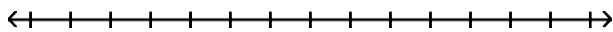

A) $(-2, 2)$

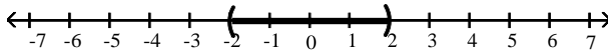

B) $(-\infty, -2) \cup (2, \infty)$

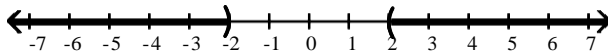

C) $[-2, 2]$

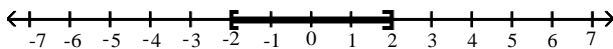

D) $(-\infty, 2]$

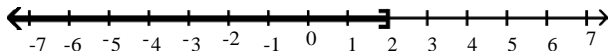

Answer: A

239) $|x + 11| < 3$

A) $(-\infty, -14)$

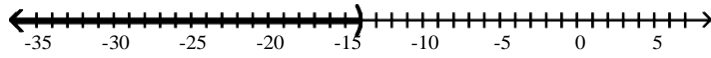

B) $(8, 14)$

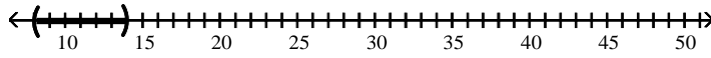

C) $(-\infty, -8)$

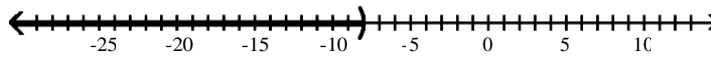

D) $(-14, -8)$

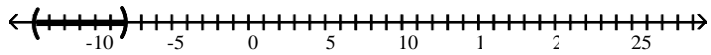

Answer: D

240) $|4k - 8| \leq 3$

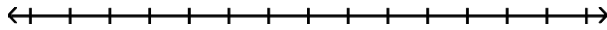

A) $\left(\frac{5}{4}, \frac{11}{4}\right)$

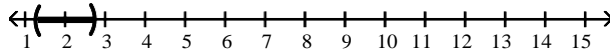

B) $\left(-\infty, \frac{5}{4}\right] \cup \left[\frac{11}{4}, \infty\right)$

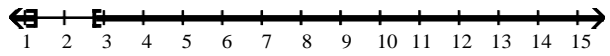

C) $\left(-\infty, \frac{11}{4}\right]$

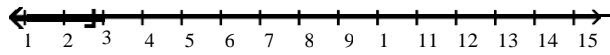

D) $\left[\frac{5}{4}, \frac{11}{4}\right]$

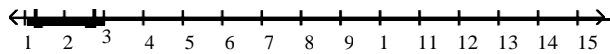

Answer: D

241) $|x| + 8 \leq 11$

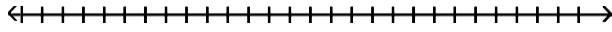

A) $(-\infty, 19]$

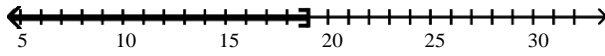

B) $[-3, 3]$

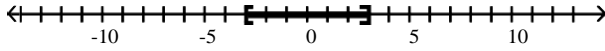

C) $(-\infty, -3] \cup [3, \infty)$

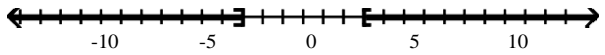

D) $(-\infty, 3]$

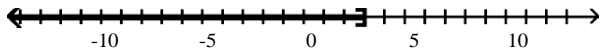

Answer: B

242) $|5k + 8| < -5$

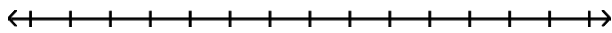

A) $\left(-\frac{13}{5}, -\frac{3}{5}\right)$

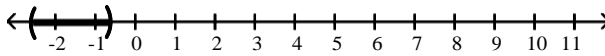

B) $\left(\frac{3}{5}, \frac{13}{5}\right)$

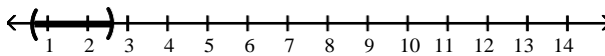

C) $\left(-\infty, -\frac{13}{5}\right) \cup \left(-\frac{3}{5}, \infty\right)$

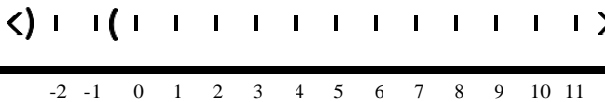

D) \emptyset

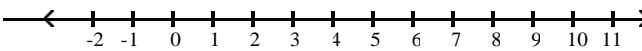

Answer: D

243) $|x - 1| + 5 \leq 10$

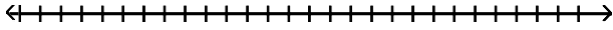

A) $[-4, 10]$

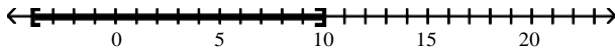

B) $[-4, 6]$

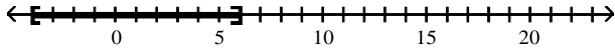

C) $(-4, 6)$

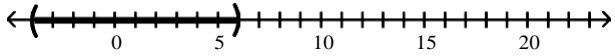

D) \emptyset

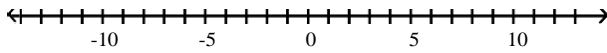

Answer: B

244) $|2k + 4| + 8 < 13$

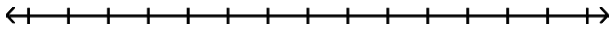

A) $\left(-\infty, \frac{1}{2}\right)$

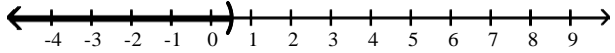

B) $\left(-\frac{9}{2}, \frac{1}{2}\right)$

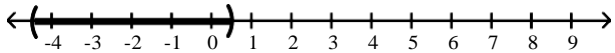

C) $\left(-\infty, -\frac{9}{2}\right) \cup \left(\frac{1}{2}, \infty\right)$

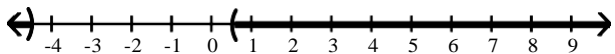

D) $\left(-\infty, -\frac{9}{2}\right)$

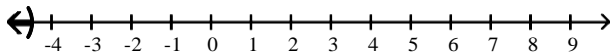

Answer: B

245) $|x| < -3$

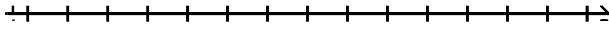

A) $(-\infty, -3) \cup (3, \infty)$

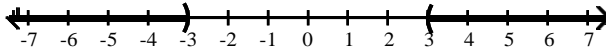

B) $(-3, 3)$

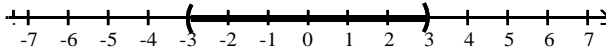

C) $(-\infty, -3]$

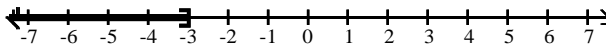

D) \emptyset

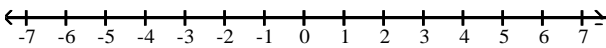

Answer: D

246) $|x - 2| \leq 0$

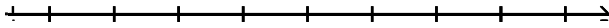

A) $(-\infty, 2)$

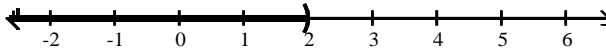

B) 2

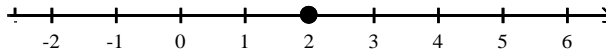

C) -2

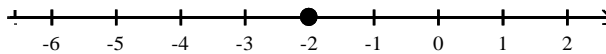

D) \emptyset

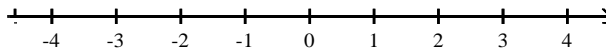

Answer: B

247) $\left| \frac{5y + 20}{4} \right| < 5$

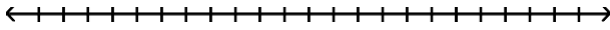

A) $(-\infty, -8) \cup (0, \infty)$

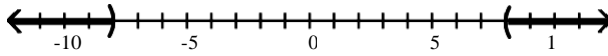

B) $(-8, 0)$

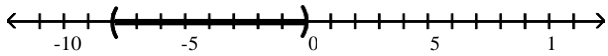

C) $(0, 8)$

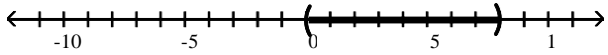

D) $(-8, 8)$

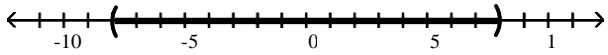

Answer: B

248) $|x| \geq 4$

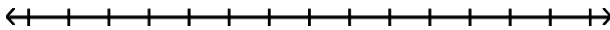

A) $[4, \infty)$

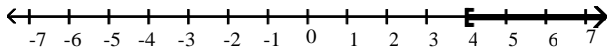

B) $[-4, 4]$

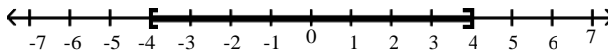

C) $(-\infty, -4) \cup (4, \infty)$

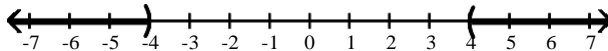

D) $(-\infty, -4] \cup [4, \infty)$

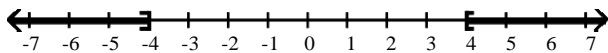

Answer: D

249) $|x| > 3$

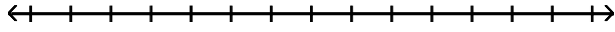

A) $[-3, 3]$

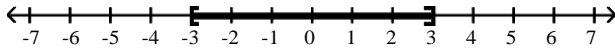

B) $(-3, 3)$

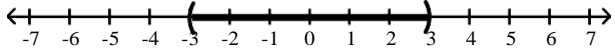

C) $(-\infty, -3) \cup (3, \infty)$

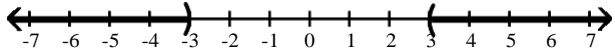

D) $[3, \infty)$

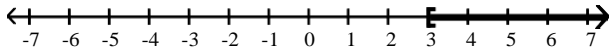

Answer: C

250) $|x - 12| > 11$

A) $(-23, -1)$

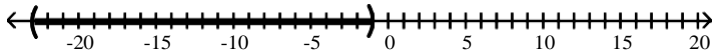

B) $(1, 23)$

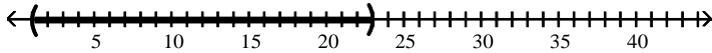

C) $(-\infty, 1) \cup (23, \infty)$

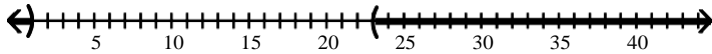

D) $(23, \infty)$

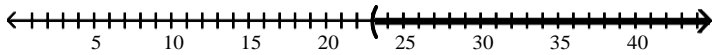

Answer: C

251) $|5k + 8| \geq 6$

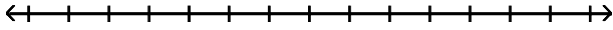

A) $\left[-\frac{2}{5}, \infty\right)$

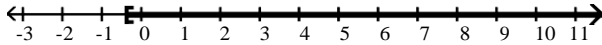

B) $\left(-\frac{14}{5}, -\frac{2}{5}\right)$

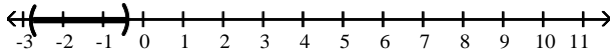

C) $\left(-\infty, -\frac{14}{5}\right] \cup \left[-\frac{2}{5}, \infty\right)$

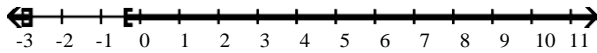

D) $\left[-\frac{14}{5}, -\frac{2}{5}\right]$

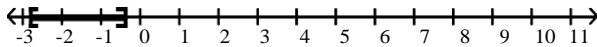

Answer: C

252) $|x| + 9 \geq 17$

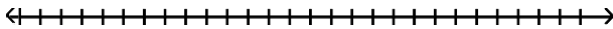

A) $(-\infty, -8] \cup [8, \infty)$

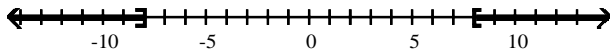

B) $[26, \infty)$

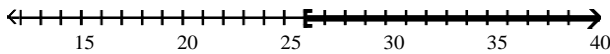

C) $[8, \infty)$

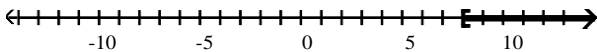

D) $[-8, 8]$

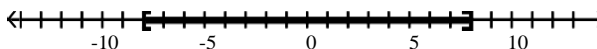

Answer: A

253) $|5k + 5| > -2$

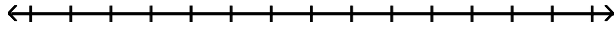

A) $\left(-\infty, -\frac{7}{5}\right) \cup \left(-\frac{3}{5}, \infty\right)$

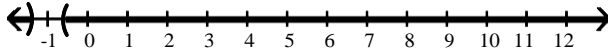

B) $\left(-\frac{3}{5}, \infty\right)$

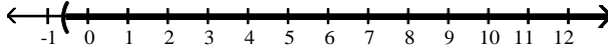

C) $\left(-\frac{7}{5}, -\frac{3}{5}\right)$

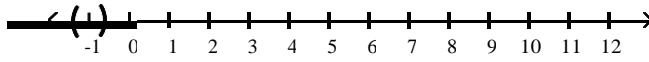

D) $(-\infty, \infty)$

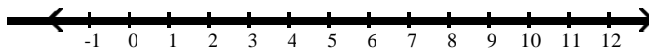

Answer: D

254) $|x - 3| + 5 \geq 13$

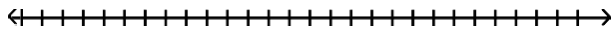

A) $[11, \infty)$

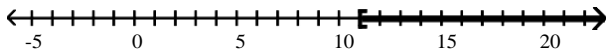

B) $(-\infty, -5] \cup [11, \infty)$

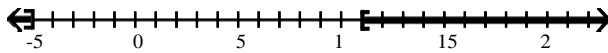

C) $[-5, 11]$

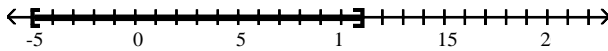

D) $(-5, 11)$

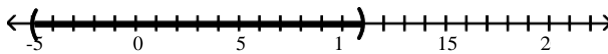

Answer: B

255) $|4k + 9| + 2 > 4$

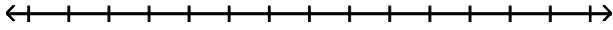

A) $\left(-\infty, -\frac{11}{4}\right) \cup \left[-\frac{7}{4}, \infty\right)$

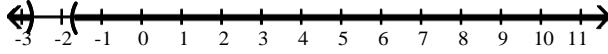

B) $\left[-\frac{11}{4}, -\frac{7}{4}\right)$

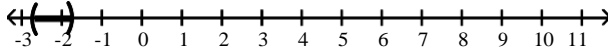

C) $\left[-\frac{7}{4}, \infty\right)$

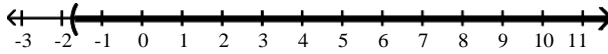

D) $\left(-\infty, -\frac{11}{4}\right] \cup \left[-\frac{7}{4}, \infty\right)$

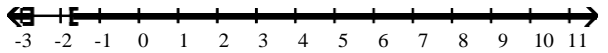

Answer: A

256) $|x| > -2$

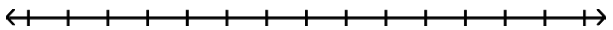

A) $[-2, \infty)$

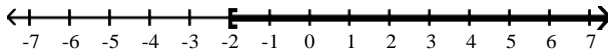

B) $(-2, 2)$

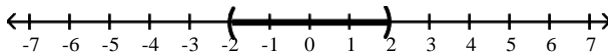

C) $(-\infty, -2) \cup (2, \infty)$

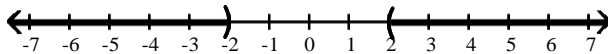

D) $(-\infty, \infty)$

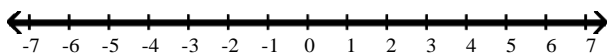

Answer: D

257) $|x + 5| \geq 0$

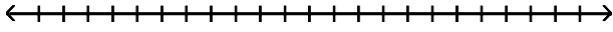

A) $(-\infty, -5) \cup (-5, \infty)$

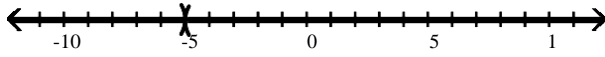

B) $(-\infty, 5) \cup (5, \infty)$

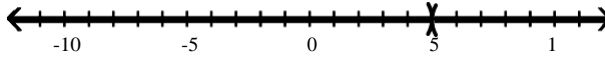

C) -5

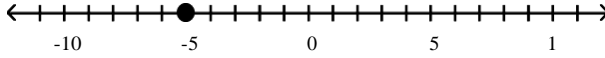

D) $(-\infty, \infty)$

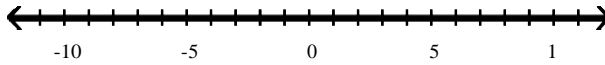

Answer: D

258) $\left| \frac{2y + 6}{3} \right| > 2$

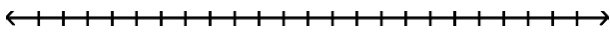

A) $(-\infty, -6) \cup (0, \infty)$

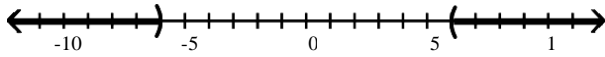

B) $(-6, 0)$

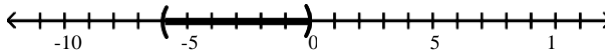

C) $(-6, 6)$

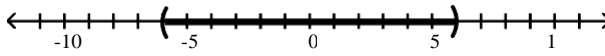

D) $(0, \infty)$

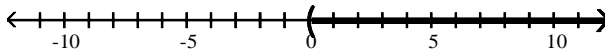

Answer: A

259) $|4x - 11| > 0$

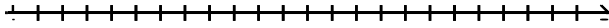

A) $\left(\frac{11}{4}, \infty\right)$

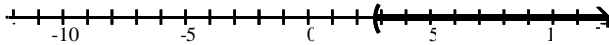

B) $\left[-\frac{11}{4}, \frac{11}{4}\right]$

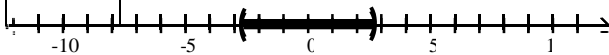

C) $\left(-\infty, -\frac{11}{4}\right) \cup \left(\frac{11}{4}, \infty\right)$

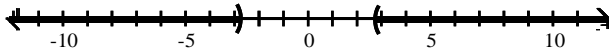

D) $\left(-\infty, \frac{11}{4}\right) \cup \left(\frac{11}{4}, \infty\right)$

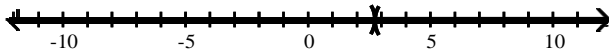

Answer: D

Solve the problem.

260) The length ℓ of a metal rod used in manufacturing cars must not differ from the standard s by more than 0.4 inches. The manufacturing engineers express this as $|\ell - s| \leq 0.4$. Find the limits of ℓ if the standard s is 22.9.

- A) $23.3 \leq \ell \leq 23.7$ B) $\ell \leq 22.5$ or $\ell \geq 23.3$ C) $\ell \leq 23.3$ or $\ell \geq 23.7$ D) $22.5 \leq \ell \leq 23.3$

Answer: D

261) The radius r of a plastic tube used in manufacturing a child's toy must not differ from the standard s by more than 3 millimeters. The manufacturing engineers express this as $|r - s| \leq 3$. Find the limits of r if the standard s is 37.

- A) $r \leq 31$ or $r \geq 34$ B) $31 \leq r \leq 34$ C) $r \leq 34$ or $r \geq 40$ D) $34 \leq r \leq 40$

Answer: D

262) A plastic rod used in manufacturing boats must be rejected if it differs in length from the standard length, s , by 0.13 inches or more. If the length of a rod is denoted by l , engineers express this relationship as $|l - s| \geq 0.13$. What are the values of l for which the part will be rejected, if the standard length is 14.10 inches?

- A) $13.97 \leq l \leq 14.23$ B) $l \leq 13.95$ or $l \geq 14.24$ C) $l \leq 13.97$ or $l \geq 14.23$ D) $l \geq 14.23$

Answer: C

Provide an appropriate response.

263) Write the relation as a map. Then identify the domain and the range of the relation.

$\{(4, 20), (5, 25), (6, 30), (7, 35)\}$

A)

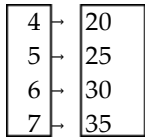

domain: {20, 25, 30, 35}
range: {4, 5, 6, 7}

B)

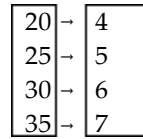

domain: {4, 5, 6, 7}
range: {20, 25, 30, 35}

C)

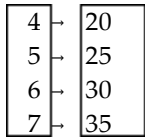

domain: {4, 5, 6, 7}
range: {20, 25, 30, 35}

D)

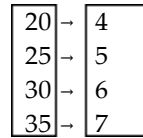

domain: {20, 25, 30, 35}
range: {4, 5, 6, 7}

Answer: C

264) Identify the domain and range of the relation from the graph.

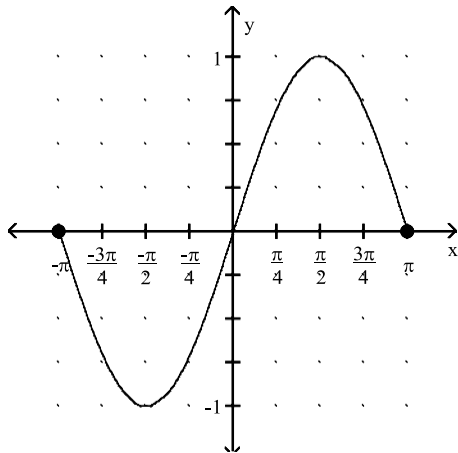

A) domain: $(-\infty, \infty)$
range: $(-\infty, \infty)$

B) domain: $[-1, 1]$
range: $[-\pi, \pi]$

C) domain: $(-\infty, \infty)$
range: $[-1, 1]$

D) domain: $[-\pi, \pi]$
range: $[-1, 1]$

Answer: D

265) Graph the relation $y = x^2 - 4$ by plotting points. Use the graph of the relation to identify the domain and range.

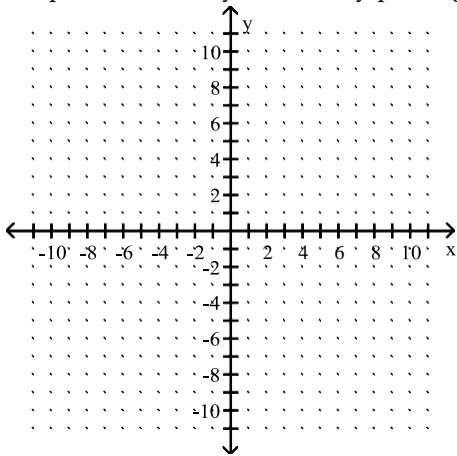

A) domain: $(-\infty, \infty)$; range: $[4, \infty)$

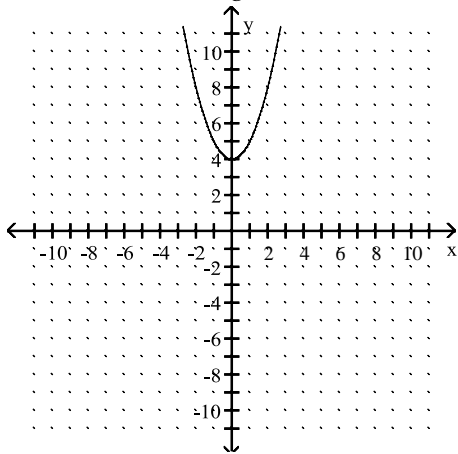

C) domain: $(-\infty, \infty)$; range: $[-4, \infty)$

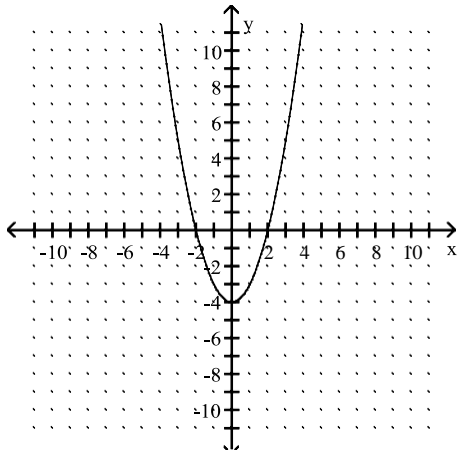

B) domain: $(-\infty, \infty)$; range: $[0, \infty)$

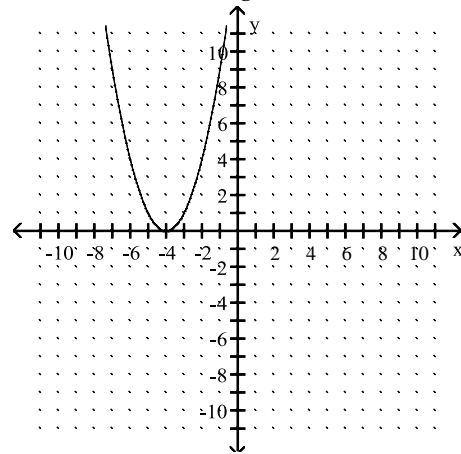

D) domain: $(-\infty, \infty)$; range: $[0, \infty)$

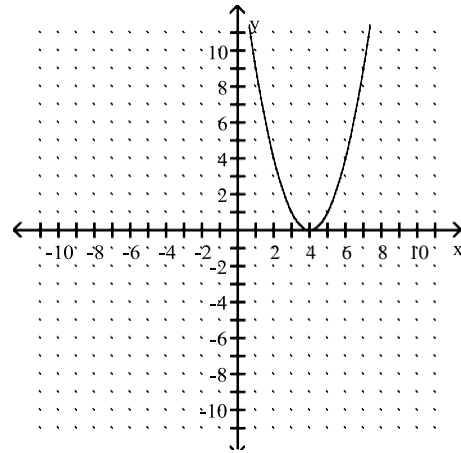

Answer: C

Determine whether the relations represent functions. Identify the domain and range of each relation.

266)

3	18
5	30
7	42
9	54

A) not a function

B) function

domain: {18, 30, 42, 54}

range: {3, 5, 7, 9}

C) function

domain: {3, 5, 7, 9}

range: {18, 30, 42, 54}

Answer: C

267)

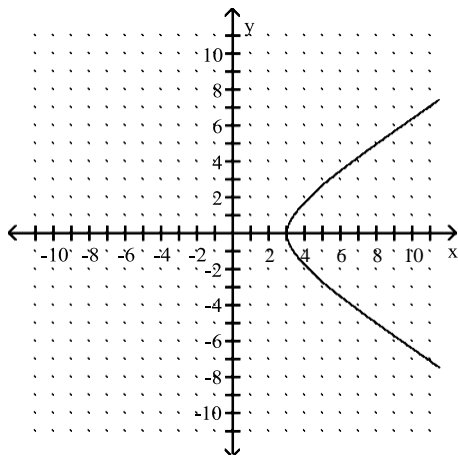

A) not a function

B) function

domain: $[3, \infty)$

range: $(-\infty, \infty)$

C) function

domain: $(-\infty, \infty)$

range: $[3, \infty)$

D) function

domain: $[0, \infty)$

range: $(-\infty, \infty)$

Answer: B

Provide an appropriate response.

268) Does the equation $y = \pm 5x$ represent a function?

A) Yes

B) No

Answer: B

269) For $f(x) = -2x + 13$, find $f(x + h)$.

A) $-2h + 13$

B) $-2x + 13h$

C) $-2x - 2h + 13$

D) $-2x + 2h + 13$

Answer: C

270) For $g(x) = x^2 + 2x - 1$, find $f(1)$.

A) 0

B) 4

C) 2

D) -2

Answer: C

271) Sketch the graph of $f(x) = -x^2 + 2$.

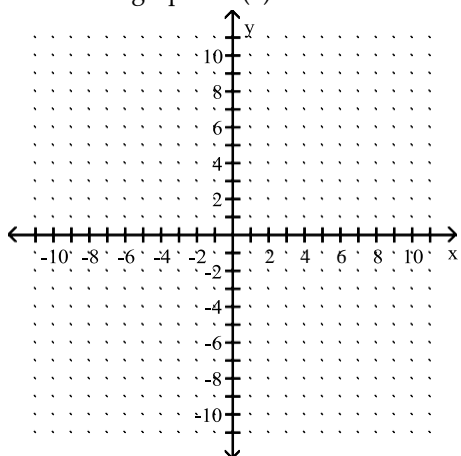

A)

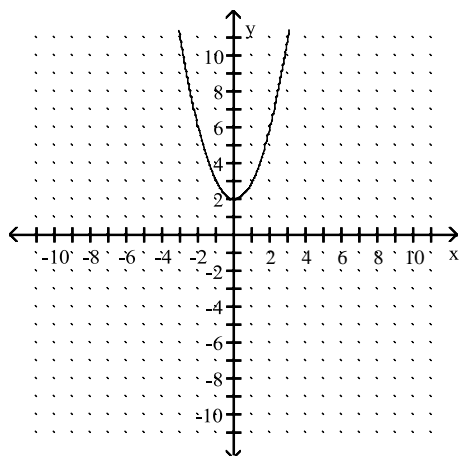

B)

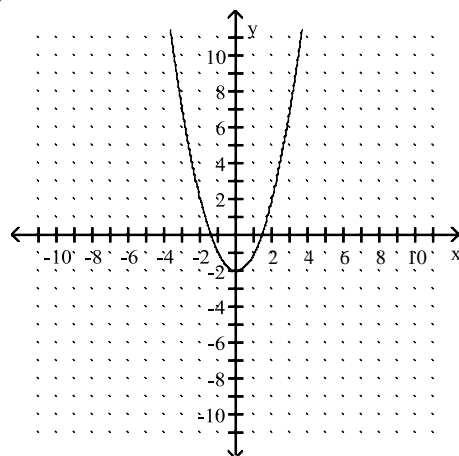

C)

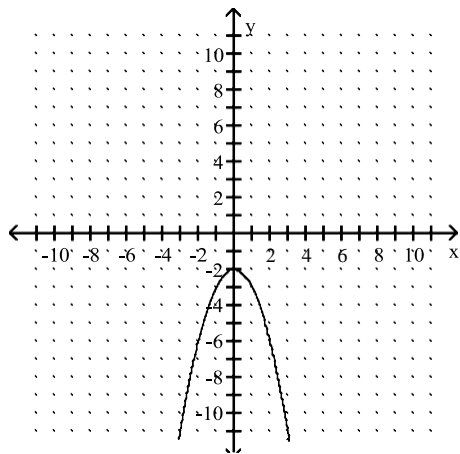

D)

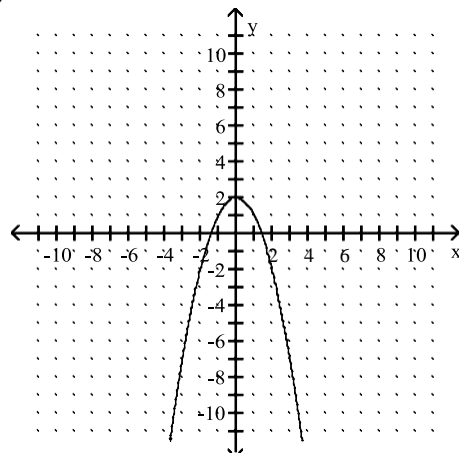

Answer: D

Solve.

- 272) Suppose economists use as a model of a country's economy the function $N(x) = 0.7478x + 6.0802$, where N represents the consumption of products in billions of dollars and x represents disposable income in billions of dollars.
- Identify the dependent and independent variables.
 - Evaluate $N(9.52)$ and explain what it represents.
 - The dependent variable is the number of billions of dollars, N , and the independent variable is the disposable income in billions of dollars.
b. $N(9.52) = \$4.6$ billion; According to the model, the number of billions of dollars for the consumption of products is \$4.6 billion.
 - The dependent variable is the number of billions of dollars, N , and the independent variable is the disposable income in billions of dollars.
b. $N(9.52) = \$5.2$ billion; According to the model, the number of billions of dollars for the consumption of products is \$5.2 billion.
 - The dependent variable is the number of billions of dollars, N , and the independent variable is the disposable income in billions of dollars.
b. $N(9.52) = \$4.4$ billion; According to the model, the number of billions of dollars for the consumption of products is \$4.4 billion.
 - The dependent variable is the number of billions of dollars, N , and the independent variable is the disposable income in billions of dollars.
b. $N(9.52) = \$13.2$ billion; According to the model, the number of billions of dollars for the consumption of products is \$13.2 billion.

Answer: A

- 273) Mike works on commission selling electronic equipment. The linear function $I(s) = 0.02s + 23,300$ describes his annual income I when his total sales for the year are s . At what level of sales will Mike's income be \$34,500?
- A) \$568,000 B) \$560,000 C) \$56,000 D) \$5,600,000

Answer: B

Provide an appropriate response.

- 274) Find the domain of $f(x) = \frac{-11}{x + 8}$

- A) $\{x \mid x \neq 8\}$ B) $\{x \mid x \neq -8\}$
C) $\{x \mid x$ is any real number $\}$ D) $\{x \mid x \neq 11\}$

Answer: B

- 275) $h(x) = -2x + 10$

- Is the point $(2, 6)$ on the graph of the function?
- If $x = 3$, what is $h(x)$? What point is on the graph of the function?
- If $h(x) = 10$, what is x ? What point is on the graph of h ?
- What is the zero of h ?
 - yes
b. $h(3) = -8$; $(3, -8)$
c. $x = -2$; $(-2, 10)$
d. 10
 - yes
b. $h(3) = 4$; $(3, 4)$
c. $x = 0$; $(0, 10)$
d. 10
 - no
b. $h(3) = 4$; $(3, 4)$
c. $x = -2$; $(-2, 10)$
d. 5
 - yes
b. $h(3) = 4$; $(3, 4)$
c. $x = 0$; $(0, 10)$
d. 5

Answer: D

Solve.

276) The following graph represents the speed of a truck as a function of time.

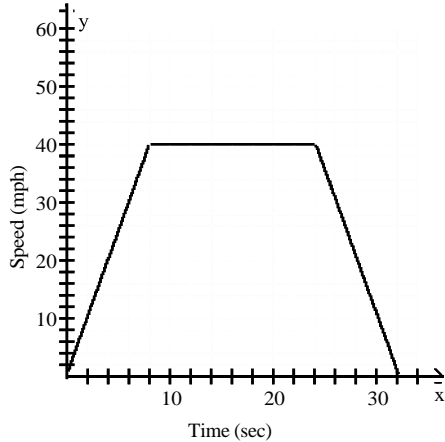

- a. When does the truck stop accelerating?
 - b. For how long does the truck maintain a constant speed?
- A) a. The truck stops accelerating when the speed stops increasing. Thus, the truck stops accelerating after 8 seconds.
b. The truck has a constant speed when the graph is horizontal. Thus, the car maintains a constant speed for 8 seconds.
- B) a. The truck stops accelerating when the speed stops increasing. Thus, the truck stops accelerating after 8 seconds.
b. The truck has a constant speed when the graph is horizontal. Thus, the car maintains a constant speed for 24 seconds.
- C) a. The truck stops accelerating when the speed stops increasing. Thus, the truck stops accelerating after 8 seconds.
b. The truck has a constant speed when the graph is horizontal. Thus, the car maintains a constant speed for 12 seconds.
- D) a. The truck stops accelerating when the speed stops increasing. Thus, the truck stops accelerating after 8 seconds.
b. The truck has a constant speed when the graph is horizontal. Thus, the car maintains a constant speed for 16 seconds.

Answer: D

SHORT ANSWER. Write the word or phrase that best completes each statement or answers the question.

277) Alice plans to sell hand-made jackets at a crafts fair for \$90 each. A booth at the fair costs \$13 to rent. Alice estimates her expenses for making each jacket to be \$30, so her profit will be \$60 per jacket.

- Write a function that expresses Alice's profit P as a function of the number of jackets sold.
- What is the implied domain of this linear function?
- What is the profit if Alice sells 25 jackets?
- Graph the linear function $P(x)$.
- If Alice's profit is \$1850, how many jackets did she sell?

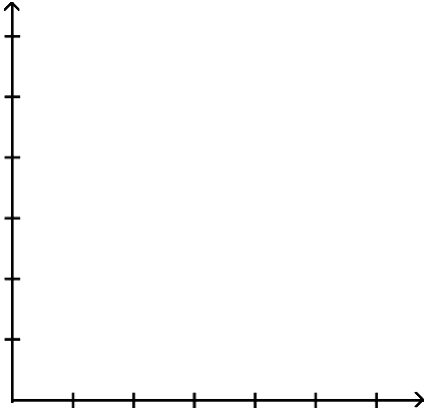

Answer: a. $P(x) = 60x - 130$

b. $[0, \infty)$

c. \$1370;

d.

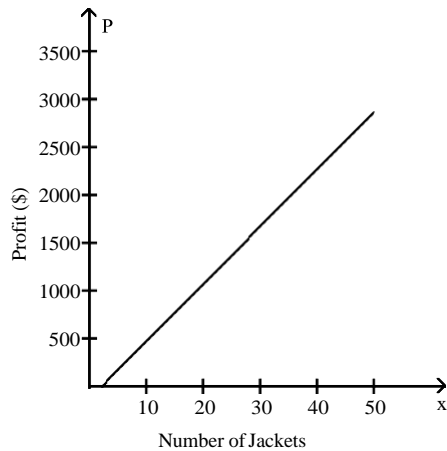

e. 33

278) Anita is interested in the relationship between age and salary for the employees of her company. She obtains the following information which shows the average annual income for employees of various ages.

Age (years), x	Average annual income (Thousands of Dollars), y
28	31.4
36	40.3
44	46.1
52	61.9
59	65.2

- Draw a scatter diagram of the data treating age as the independent variable.
- What type of relation appears to exist between age and average income?
- Find an equation of the line containing the points (36, 40.3) and (59, 65.2).
- Graph the line on the scatter diagram.
- Predict the income of an employee aged 45.
- Interpret the slope of the line.

Answer: parts **a.** and **d.**

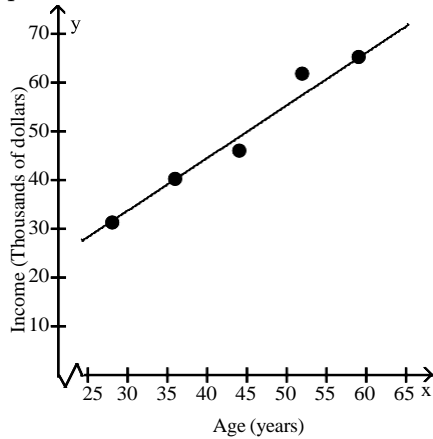

- Approximately linear.
- $y = 1.08x + 1.33$
- 50.0 thousand dollars
- An employee's income will increase by 1.08 thousand dollars for each one-year increase in age.

MULTIPLE CHOICE. Choose the one alternative that best completes the statement or answers the question.

279) Solve: $|8x + 5| - 9 = 0$

A) $\left\{ \frac{1}{2}, \frac{7}{4} \right\}$

B) $\left\{ \frac{1}{2}, -\frac{7}{4} \right\}$

C) \emptyset

D) $\left\{ \frac{4}{5}, -\frac{14}{5} \right\}$

Answer: B

Solve the inequality. Graph the solution set and write it in interval notation.

280) $-7x > -14$ and $x + 7 > 8$

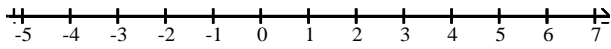

A) $(1, 2)$



B) \emptyset

C) $(-\infty, 1) \cup (2, \infty)$

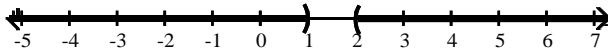

D) $(2, \infty)$

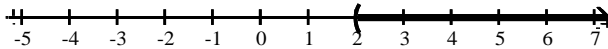

Answer: A

281) $-4x \leq -12$ or $4x > 12x - 8$

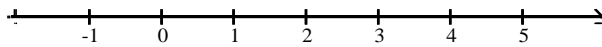

A) \emptyset

B) $(-\infty, 1] \cup (3, \infty)$

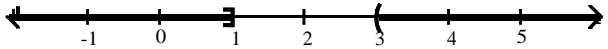

C) $(1, 3]$

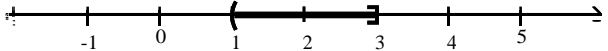

D) $(-\infty, 1) \cup [3, \infty)$

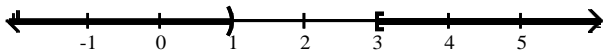

Answer: D

282) $|4k + 7| - 4 < 4$

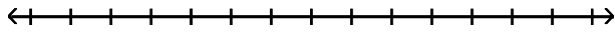

A) $\left(-\infty, -\frac{15}{4}\right) \cup \left(\frac{1}{4}, \infty\right)$

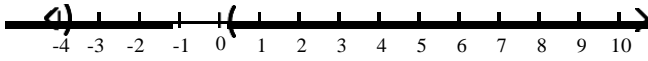

B) $\left(-\infty, -\frac{15}{4}\right)$

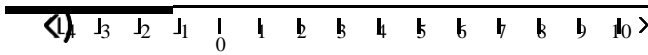

C) $\left(-\infty, \frac{1}{4}\right)$

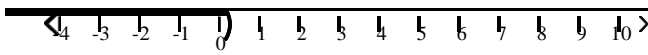

D) $\left(-\frac{15}{4}, \frac{1}{4}\right)$

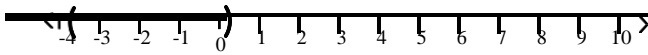

Answer: D

283) $|5k - 9| \geq 7$

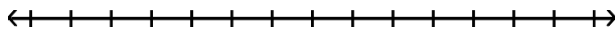

A) $\left[\frac{16}{5}, \infty\right)$

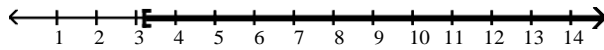

B) $\left(-\infty, \frac{2}{5}\right] \cup \left[\frac{16}{5}, \infty\right)$

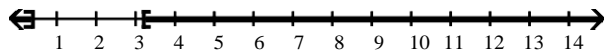

C) $\left(\frac{2}{5}, \frac{16}{5}\right)$

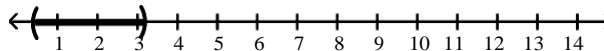

D) $\left[\frac{2}{5}, \frac{16}{5}\right]$

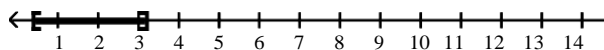

Answer: B