

Solution Manual for Physics for Scientists and Engineers Foundations and Connections Volume 2 1st Edition Katz 0534467660 9780534467661

Full link download:
Solution Manual:

<https://testbankpack.com/p/solution-manual-for-physics-for-scientists-and-engineers-foundations-and-connections-volume-2-1st-edition-katz-0534467660-9780534467661/>

23

Electric Forces

1. For a contact force, the two objects must touch. For example, normal, tension, spring, friction, drag, and buoyant forces. All of these are actually macroscopic manifestations of the electromagnetic force.

For a field force, they do not need to touch and force can exist at large separation distances. Gravity is an example.

2. Franklin said that the electric force was due to the electric fluid and when there is excess fluid, the object is positive. Hence, he did not have a particle model in mind.

3.
$$N = \frac{q}{e} = \frac{35 \times 10^{-9} \text{ C}}{1.6 \times 10^{-19} \text{ C/proton}} = 2.2 \times 10^{11}$$

protons

4. We first estimate the number of electrons in the plate. Assume it weighs around 4 ounces or 0.1 kg. It's likely made of some polymer, but let's just assume it's something carbon-based, for instance. In that case,

$$N_{\text{tot}} = 100 \text{ g} \frac{1 \text{ mol}}{12.0 \text{ g}} \times 6.02 \times 10^{23} \frac{\text{atoms}}{\text{mol}} \times 6 \frac{\text{electrons}}{\text{atom}} = 3 \times 10^{25} \text{ electrons}$$

Using Eq. 23.2, the number of excess electrons is

$$N_{\text{excess}} = \frac{q}{-e} = \frac{-75 \times 10^{-6} \text{ C}}{-1.6 \times 10^{-19} \text{ C/electron}} = 4.7 \times 10^{14} \text{ electrons}$$

Keeping only one significant figure because we were estimating, the fraction of excess charges is then

$$\frac{N_{\text{excess}}}{N_{\text{tot}}} = \frac{4.7 \times 10^{14} \text{ electrons}}{3 \times 10^{25} \text{ electrons}} \approx \boxed{2 \times 10^{-11}}$$

23-1

2016 Cengage Learning. All rights reserved. May not be scanned, copied or duplicated, or posted to a publicly accessible website, in whole or part.

5. Divide the total charge by the charge of a single electron to determine the number of electrons.

$$N = \frac{q}{-e} = \frac{-1.00 \text{ C}}{-1.60 \times 10^{-19} \text{ C/electron}} = \boxed{6.25 \times 10^{18} \text{ electrons}}$$

6. The amount of charge transferred is found by multiplying the number of electrons transferred by the charge of a single electron.

$$q = (6.25 \times 10^{18}) (-1.60 \times 10^{-19} \text{ C}) = -1.00 \times 10^{-1} \text{ C}$$

Then, the remaining charge of the sphere is found by adding this charge to the sphere's initial charge.

$$Q_{\text{sphere}} = 8.05 \times 10^{-9} \text{ C} + (-1.00 \times 10^{-1} \text{ C}) = \boxed{7.25 \times 10^{-9} \text{ C}}$$

Then, the remaining charge of the rod is found by subtracting the charge transferred from the rod's initial charge.

$$Q_{\text{rod}} = -6.03 \times 10^{-9} \text{ C} - (-1.00 \times 10^{-1} \text{ C}) = \boxed{9.37 \times 10^{-2} \text{ C}}$$

7. (a) The rod has lost mass. Electrons have been stripped from the rod, leaving behind a net positive charge.

(b) Using Eq. 23.1, the number of electrons lost is

$$N = \frac{q}{e} = \frac{45.7 \times 10^{-6} \text{ C}}{1.60 \times 10^{-19} \text{ C/electron}}$$

The mass lost is then

$$m = \frac{45.7 \times 10^{-6} \text{ C}}{1.60 \times 10^{-19} \text{ C/electron}} (9.11 \times 10^{-31} \text{ kg}) = \boxed{2.60 \times 10^{-16} \text{ kg}}$$

8. Based on Problem 7, the scarf gained about 10^{-16} kg of electrons. Assuming it has a mass of around 0.1 kg, this is a fractional increase of only 10^{-15} , which of course would not be noticeable.

9. (a) The excess charge is equal to the number of electrons times the charge per electron e .

$$N = \frac{q}{e} = \frac{-4.20 \times 10^{-6} \text{ C}}{-1.60 \times 10^{-19} \text{ C}} = 2.63 \times 10^{13} \text{ electrons}$$

(b) We can then compare this to the total number of electrons by determining the number of atoms in 50.0 g of aluminum times the number of electrons per atom.

$$50.0 \text{ g Al} \frac{\text{mol}}{27.0 \text{ g}} \times 6.02 \times 10^{23} \frac{\text{atoms}}{\text{mol}} \times 13 \frac{\text{electrons}}{\text{atom}} = 1.45 \times 10^{25} \text{ electrons}$$

Dividing by the answer to part (a) to get the desired fraction,

$$\text{fraction of electrons lost} = \frac{2.63 \times 10^{13}}{10^{12} \times 1.45 \times 10^{25}} = 1.81$$

(c) Multiply the number of electrons removed by the mass of the electron.

$$\frac{-4.20 \times 10^{-6} \text{ C}}{-1.60 \times 10^{-19} \text{ C}} \times 9.11 \times 10^{-31} \frac{\text{kg}}{\text{electron}} = 2.39 \times 10^{-17} \text{ kg} = 2.39 \times 10^{-14} \text{ g}$$

10. (a) When your socks rub the carpet, you build up extra electric fluid which is then transferred to the doorknob when you touch it.

(b) When your socks rub the carpet, electrons are transferred, and you either gain or lose electrons. When you touch the doorknob, excess electrons are then transferred to or from the doorknob.

11. Yes. When silk and glass are rubbed, they become oppositely charged. Similarly, the wool and plastic are oppositely charged. Therefore, if glass and plastic attract (are oppositely charged), then the silk and wool must also be oppositely charged and will attract.

12. When you rub on the seat, you gain or lose electric fluid, which is transferred to the gas pump like lightning. If we think of this fluid as a current of electrons, our explanations are the same.

13. Rubber is an insulator and prevents electrical discharge or shocks.

14. The chopstick will be attracted to the charged object because there will be an induced polarization due to the formation of dipoles at the microscopic scale.

15. We calculate the number of electrons and the surface area of the sphere, using the results to calculate the number density.

$$N = \frac{q}{e} = \frac{-36.3 \times 10^{-9} \text{ C}}{-1.60 \times 10^{-19} \text{ C/electron}} = 2.27 \times 10^{11} \text{ electrons}$$

$$A = 4\pi r^2 = 4(3.14)(0.0435 \text{ m})^2 = 0.0238 \text{ m}^2$$

$$\frac{N}{A} = \frac{2.27 \times 10^{11}}{0.0238 \text{ m}^2} = 9.54 \times 10^{12} \text{ m}^{-2}$$

16. The charges will be divided evenly and each will have a final charge of +15.0 μC, regardless of how contact is made.

17. The charges will not move easily and would not easily be transferred between the two objects. So the charged insulator retains a net charge of +30.0 μC, and the other retains a net charge of 0. However, it does matter how the contact is made. If either of the insulators is moved while they are in contact, such that a friction force acts on each insulator over a short distance, charges can be transferred from one to the other.

18. The negatively charged insulating plate induces a polarization on the conductor, with a net positive charge of the bottom. The connection to ground then allows the negative charge on top to drain, leaving a net positive charge on the conductor.

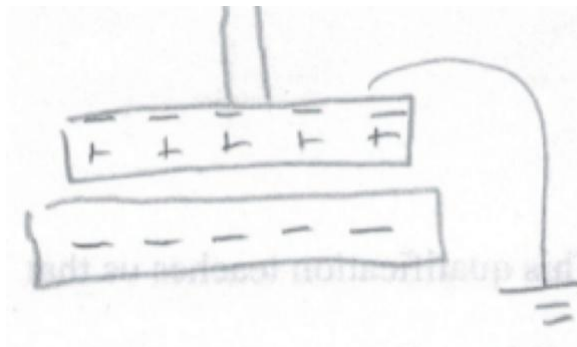

Figure P23.18ANS

19. The amount of charge might decrease, but any charge will be distributed around the entire conductor surface at the end.

20. (a) When the positively charged object is brought close to the electroscope, it becomes polarized, leaving a net positive charge at the bottom. The two rods are positively charged and repel, causing the moveable rod to rotate away.

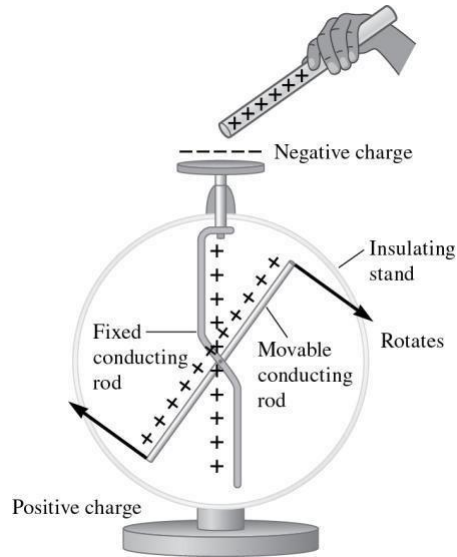

Figure P23.20aANS

(b) Without the positive charge polarizing the electroscope, the charge on the platform returns to the bottom. The neutral electroscope is then uncharged as it was initially.

(c) When the negatively charged object is brought close, the electroscope polarizes in the opposite way as in part (a), leaving a net negative charge at the bottom. Since the two rods are negatively charged, they again repel, and the moveable rod rotates away from the fixed one.

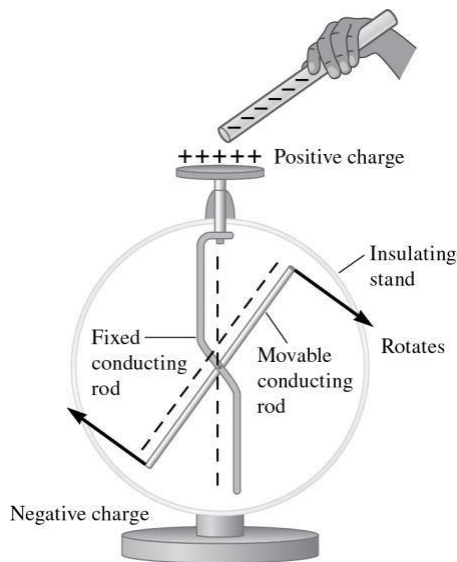

Figure P23.20bANS

(d) Charge is transferred to the electroscope, causing it to have a net charge even when the object is removed. The moveable rod will rotate away from the fixed one.

21. (a) Using Coulomb's law (Eq. 23.3),

$$|F| = \frac{k |q_1 q_2|}{r^2}$$

$$F = k e e = \frac{(8.99 \times 10^9 \text{ N} \cdot \text{m}^2 / \text{C}^2)(5.50 \times 10^{-9} \text{ C})(8.95 \times 10^{-9} \text{ C})}{r^2 (3.00 \text{ m})^2}$$

$$= 4.92 \times 10^{-8} \text{ N}$$

(b) The charges are opposite charges. The force is attractive.

22. Applying Coulomb's law (Eq. 23.3),

$$F_E = \frac{k |q_1 q_2|}{r^2} \rightarrow r = \sqrt{\frac{k |q_1 q_2|}{F}}$$

$$r = \sqrt{\frac{8.99 \times 10^9 \text{ N} \cdot \text{m}^2 / \text{C}^2 \cdot 34.5 \times 10^{-9} \text{ C} \cdot 54.3 \times 10^{-9} \text{ C}}{2.70 \times 10^{-4} \text{ N}}} = 0.250 \text{ m}$$

23. Applying Coulomb's law (Equation 23.3), we solve for q and insert numerical values.

$$F = \frac{k q^2}{r^2} \rightarrow q = \sqrt{\frac{F r^2}{k}} = \sqrt{\frac{(2.3)(1.52)}{8.99 \times 10^9}} = 2.4 \times 10^{-5} \text{ C}$$

Each coin must have the same charge for the force to be repulsive.

24. Equation 23.5 is

$$\mathbf{F} = \frac{k q_1 q_2}{r^2} \hat{r}$$

[1 on 2]

where \hat{r} points from Particle 1 to 2. If the charges are either both positive or both negative, the calculated value will be positive, and the force on 2 due to 1 points away from Particle 1, i.e. is repulsive (see Fig. 23.23). If they have opposite signs, the calculated value will be negative, so the force will have a direction opposite the unit vector and the force on Particle 2 will be towards 1.

25. According to Eq. 23.3, the force depends on the inverse square of the separation, so if the force is 4 times larger, the separation must be half of the original value, $r_i/2$.

26. (a) The force is attractive since the particles have opposite charges.

(b) The distance r in Coulomb's law is the distance between the particles. The magnitude of the force is (Eq. 23.3)

$$F = \frac{k_e q_1 q_2}{r^2} = \frac{(8.99 \times 10^9 \text{ N} \cdot \text{m}^2 / \text{C}^2) (25.0 \times 10^{-6} \text{ C}) (15.0 \times 10^{-6} \text{ C})}{(0.550 \text{ m})^2} = 11.1 \text{ N}$$

27. The electric force on each particle will be equal in magnitude but opposite in direction. The magnitude of the force is given by Eq. 23.3.

$$F = \frac{k_e q_1 q_2}{r^2} = \frac{(8.99 \times 10^9 \text{ N} \cdot \text{m}^2 / \text{C}^2) (1.75 \times 10^{-9} \text{ C}) (2.88 \times 10^{-9} \text{ C})}{(0.0825 \text{ m})^2} = 6.66 \times 10^{-6} \text{ N}$$

Note that both particles have a positive net charge. Thus, they will repel each other. So

(a) the force on the 2.88-nC particle will be $6.66 \times 10^{-6} \text{ N}$, and (b) the force on the 1.75-nC particle will be $-6.66 \times 10^{-6} \text{ N}$

28. The magnitude of the electric force between the particles is initially given by

$$F_{\text{initial}} = \frac{k_e |q_1 q_2|}{r^2} = \frac{(8.99 \times 10^9 \text{ N} \cdot \text{m}^2 / \text{C}^2) (1.75 \times 10^{-9} \text{ C}) (2.88 \times 10^{-9} \text{ C})}{(0.0825 \text{ m})^2}$$

The final electric force should be twice as much, so we use Eq. 23.3 again and solve for the new charge separation distance, r .

$$F_{\text{final}} = 2F_{\text{initial}}$$

$$(8.99 \times 10^9 \text{ N} \cdot \text{m}^2 / \text{C}^2) \frac{(1.75 \times 10^{-9} \text{ C})(2.88 \times 10^{-9} \text{ C})}{r^2} = 2 \left((8.99 \times 10^9 \text{ N} \cdot \text{m}^2 / \text{C}^2) \frac{(1.75 \times 10^{-9} \text{ C})(2.88 \times 10^{-9} \text{ C})}{(0.0825 \text{ m})^2} \right)$$

$$\frac{1}{r^2} = 2 \frac{1}{(0.0825 \text{ m})^2}$$

$$r = 0.0583 \text{ m}$$

29. (a) Use Eq. 23.3 to express the initial electric force between the particles.

$$F = \frac{k q_1 q_2}{r^2}$$

Now, use the same equation to solve for r , where the electric force magnitude would be halved.

$$F = \frac{1}{2} F_E$$

$$\frac{k|q_1q_2|}{r^2} = \frac{1}{2} \frac{k|q_1q_2|}{d^2}$$

$$\frac{1}{r^2} = \frac{1}{2d^2}$$

$$r = \boxed{d\sqrt{2}}$$

(b) Use Eq. 23.3 to solve for r , where the electric force magnitude would be doubled. $F=2F_E$

$$\frac{k|q_1q_2|}{r^2} = 2 \frac{k|q_1q_2|}{d^2}$$

$$\frac{1}{r^2} = \frac{2}{d^2}$$

$$r = \boxed{d/\sqrt{2}}$$

30. The attractive electrostatic force between the electron and the positively charged nucleus is the centripetal force keeping the electron in orbit. Setting the Coulomb force (Eq. 23.3) equal to the centripetal force, we can then solve for the speed, v .

$$\frac{Ze^2}{k r^2} = m \frac{v^2}{r} \rightarrow \boxed{v = \sqrt{\frac{kZe^2}{mr}}}$$

31. (a) Using Coulomb's law (Eq. 23.3),

$$F_E = \frac{k|q_1q_2|}{r^2} = \frac{(8.99 \times 10^9 \text{ N} \cdot \text{m}^2/\text{C}^2) (-1.60 \times 10^{-19} \text{ C})^2}{(5.00 \times 10^{-11} \text{ m})^2} = \boxed{9.21 \times 10^{-8} \text{ N}}$$

(b) We calculate the gravitational force and then take the ratio, which is *huge*, as we would predict.

$$F_g = \frac{Gm_1m_2}{r^2} = \frac{(6.67 \times 10^{-11} \text{ N} \cdot \text{m}^2/\text{C}^2)(9.11 \times 10^{-31} \text{ kg})^2}{(5.00 \times 10^{-11} \text{ m})^2} = 2.21 \times 10^{-50} \text{ N}$$

$$\frac{F_g}{F_E} = \frac{2.21 \times 10^{-50} \text{ N}}{9.21 \times 10^{-8} \text{ N}} = \boxed{2.4 \times 10^{-43}}$$

$$F = 2.21 \times 10^{-50} \text{ N} = \frac{4.16 \times 10}{g}$$

32. (a) The charges will be distributed equally, so each ball will have charge.

$$(5.0 + 15.0)/2 \text{ } \mu\text{C} = \boxed{10.0 \text{ } \mu\text{C}}$$

(b) The charge q_1 increases by a factor of 2 while the charge q_2 decreases by a factor of 2/3. Since the Coulomb force (Eq. 23.3) depends on the product q_1q_2 , the force increase by a factor of

$$(2)(2/3) = 4/3 = \boxed{1.33}$$

33. We use Coulomb's law to calculate the electrostatic force and Newton's law of gravitation to find the gravitational force between the balls and then determine the charge when they are equal.

$$k \frac{|q_1 q_2|}{r^2} = G \frac{m_1 m_2}{r^2}$$

$$\left(8.99 \times 10^9 \text{ N} \cdot \text{m} / \text{C}^2 \right) \frac{q^2}{(1.0 \text{ m})^2} = \left(6.67 \times 10^{-11} \text{ N} \cdot \text{m} / \text{kg}^2 \right) \frac{(5.0 \times 10^{-3} \text{ kg})(5.0 \times 10^{-3} \text{ kg})}{(1.0 \text{ m})^2}$$

$$q^2 = 0.19 \times 10^{-24} \text{ C}^2$$

$$q = \boxed{\pm 4.3 \times 10^{-13} \text{ C}} = \pm 0.43 \text{ pC}$$

34. The electric force on q_A (found using Eq. 23.3, Coulomb's law) is balanced by the spring force ($F = -Kx$), where K is the spring constant (to avoid confusion with the constant k in Coulomb's law).

$$\frac{k q q}{A-B} = Kx$$

$$x = \frac{k |q_1 q_2|}{Kd} = \frac{(8.99 \times 10^9 \text{ N} \cdot \text{m}^2 / \text{C}^2)(2.00 \times 10^{-6} \text{ C})(3.60 \times 10^{-6} \text{ C})}{(125 \text{ N/m})(0.120 \text{ m})^2} = \boxed{0.0360 \text{ m}} = 3.60 \text{ cm}$$

35. We relate the equal-magnitude charges on both spheres to the electrostatic force (Eq. 23.3) and solve for q .

$$F_E = k \frac{|q_1 q_2|}{r^2} = k \frac{q^2}{r^2}$$

$$q = r \sqrt{\frac{F}{k}} = (0.750 \text{ m}) \sqrt{\frac{1.00 \times 10^5 \text{ N}}{8.99 \times 10^9 \text{ N} \cdot \text{m}^2 / \text{C}^2}} = 2.50 \times 10^{-3} \text{ C}$$

The number of electrons transferred is then

$$N = \frac{q}{e} = \frac{2.50 \times 10^{-3} \text{ C}}{1.60 \times 10^{-19} \text{ C/e}^-} = 1.56 \times 10^{16} \text{ electrons}$$

The total number of electrons in each sphere is

$$N_{\text{tot}} = \frac{25.0 \text{ g}}{63.5463 \text{ g/mol}} (6.022 \times 10^{23} \text{ atoms/mol}) (29 \text{ e}^- / \text{atom}) = 6.87 \times 10^{24} \text{ e}^-$$

63.5463 g/mol

The fraction transferred is then

$$f = \frac{N_{\text{xfer}}}{N_{\text{tot}}} = \frac{1.56 \times 10^{16}}{6.87 \times 10^{24}} = 2.28 \times 10^{-9}$$

or two out of every billion electrons.

36. **Yes.** If the other two charged particles have opposite signs and the closer particle has less charge, the forces on the end particle due to these particles may be equal and opposite, leading to zero net electrostatic force.

37. Note that both particles will exert a force on the 5.00-nC particle that is directed to the left, or in the $-x$ direction. Use Eq. 23.3 to find the electric force of the -10.00 -nC particle on the 5.00-nC particle.

$$F_{-10.00} = \frac{k |q_1 q_2|}{r^2} = \frac{(8.99 \times 10^9 \text{ N} \cdot \text{m}^2 / \text{C}^2) |(-10.00 \times 10^{-9} \text{ C})(5.00 \times 10^{-9} \text{ C})|}{(0.0350 \text{ m})^2}$$

$$F_{-10.00} = 3.67 \times 10^{-4} \text{ N}$$

$$\mathbf{F}_{-10.00} = -3.67 \times 10^{-4} \hat{i} \text{ N}$$

Then, use Eq. 23.3 to find the electric force of the 3.00-nC particle on the 5.00-nC particle.

2016 Cengage Learning. All rights reserved. May not be scanned, copied or duplicated, or posted to a publicly accessible website, in whole or part.

$$F = \frac{k |q_1 q_2|}{r^2} = (8.99 \times 10^9 \text{ N} \cdot \text{m}^2 / \text{C}^2) \frac{(3.00 \times 10^{-9} \text{ C})(5.00 \times 10^{-9} \text{ C})}{(0.0150 \text{ m})^2}$$

$$F = 5.99 \times 10^{-4} \text{ N}$$

$$F_{3.00} = -5.99 \times 10^{-4} \hat{i} \text{ N}$$

Finally, use the principle of superposition to find the net electric force.

$$F_{\text{net}} = F_{-10.00} + F_{3.00} = (-3.67 \times 10^{-4} \hat{i} - 5.99 \times 10^{-4} \hat{i}) \text{ N} = \boxed{-9.66 \times 10^{-4} \hat{i} \text{ N}}$$

38. First, use the geometry of the figure to find the distance between the 5.65-μC particle and each of the others.

$$d_{10.33} = \sqrt{-0.0200 \text{ m} - 0.0100 \text{ m}^2 + 0.0100 \text{ m}^2}$$

$$d_{10.33}^2 = 1.00 \times 10^{-3} \text{ m}^2$$

$$d_{-15.12} = \sqrt{0.0200 \text{ m}^2 + 0.0100 \text{ m}^2}$$

$$d_{-15.12} = 5.00 \times 10^{-4} \text{ m}$$

Then, use Eq. 23.3 to find the magnitude of the electric force between each of the particles and the 5.65-μC particle.

$$F_{10.33} = \frac{k |q_1 q_2|}{r^2} = (8.99 \times 10^9 \text{ N} \cdot \text{m}^2 / \text{C}^2) \frac{(10.33 \times 10^{-6} \text{ C})(5.65 \times 10^{-6} \text{ C})}{1.00 \times 10^{-3} \text{ m}^2}$$

$$F_{-15.12} = \frac{k |q_1 q_2|}{r^2} = (8.99 \times 10^9 \text{ N} \cdot \text{m}^2 / \text{C}^2) \frac{(-15.12 \times 10^{-6} \text{ C})(5.65 \times 10^{-6} \text{ C})}{5.00 \times 10^{-4} \text{ m}^2}$$

Next, determine the direction of the electric force in each case by finding the magnitude of the angle of the lines of action, with respect to the positive x axis, between each of the particles and the 5.65-μC particle. We retain extra digits for the application of the significant figure rules when later computing the net force.

$$\tan\theta_{10.33} = \left| \frac{0.0100 \text{ m}}{0.0300 \text{ m}} \right|$$

$$\theta_{10.33} = 18.435^\circ$$

$$\tan\theta_{-15.12} = \left| \frac{0.0100 \text{ m}}{0.0200 \text{ m}} \right|$$

$$\theta_{-15.12} = 26.565^\circ$$

We must now write each of the electric forces as a vector in component form. For the 10.33- μC particle, the force is repulsive and will result in negative x and y components.

$$F_{10.33} = \left(8.99 \times 10^9 \text{ N} \cdot \text{m}^2 / \text{C}^2 \right) \left(\frac{10.33 \times 10^{-6} \text{ C}}{1.00 \times 10^{-3} \text{ m}} \right) \left(\frac{5.65 \times 10^{-6} \text{ C}}{1.00 \times 10^{-3} \text{ m}} \right) \left[-\cos(18.435^\circ)\hat{i} - \sin(18.435^\circ)\hat{j} \right]$$

$$F_{10.33} = (-498\hat{i} - 166\hat{j})\text{N}$$

For the -15.12- μC particle, the force is attractive and will result in positive x and negative y components. We retain extra digits for the application of the significant figure rules when later computing the net force.

$$F_{-15.12} = \left(8.99 \times 10^9 \text{ N} \cdot \text{m}^2 / \text{C}^2 \right) \left(\frac{-15.12 \times 10^{-6} \text{ C}}{5.00 \times 10^{-4} \text{ m}} \right) \left(\frac{5.65 \times 10^{-6} \text{ C}}{5.00 \times 10^{-4} \text{ m}} \right) \left[\cos(26.565^\circ)\hat{i} - \sin(26.565^\circ)\hat{j} \right]$$

$$F_{-15.12} = (1.374 \times 10^3 \hat{i} - 687\hat{j})\text{N}$$

The net electric force is then found using the principle of superposition.

$$F_{\text{net}} = (-498\hat{i} - 166\hat{j})\text{N} + (1.374 \times 10^3 \hat{i} - 687\hat{j})\text{N} = (876\hat{i} - 853\hat{j})\text{N}$$

39. First, use the geometry of the figure to find the distance between the 10.33- μC particle and each of the others.

$$d_{5.65} = \sqrt{(-0.0200 \text{ m} - 0.0100 \text{ m})^2 + (0.0100 \text{ m})^2}$$

$$d_{5.65}^2 = 1.00 \times 10^{-3} \text{ m}^2$$

$$d_{-15.12} = \sqrt{(0.0100 \text{ m})^2 + (0.0100 \text{ m} + 0.0100 \text{ m})^2}$$

$$d_{-15.12}^2 = 5.00 \times 10^{-4} \text{ m}^2$$

Then, use Eq. 23.3 to find the magnitude of the electric force between each of the particles and the 10.33- μC particle.

$$F_{5.65} = \frac{k |q_1 q_2|}{r^2} = (8.99 \times 10^9 \text{ N} \cdot \text{m}^2 / \text{C}^2) \frac{(5.65 \times 10^{-6} \text{ C})(10.33 \times 10^{-6} \text{ C})}{(1.00 \times 10^{-3} \text{ m})^2}$$

$$F_{-15.12} = \frac{k |q_1 q_2|}{r^2} = (8.99 \times 10^9 \text{ N} \cdot \text{m}^2 / \text{C}^2) \frac{(-15.12 \times 10^{-6} \text{ C})(10.33 \times 10^{-6} \text{ C})}{(5.00 \times 10^{-4} \text{ m})^2}$$

Next, determine the direction of the electric force in each case by finding the magnitude of the angle of the lines of action, with respect to the positive x axis, between each of the particles and the 10.33- μC particle. We retain extra digits for the application of the significant figure rules when later computing the net force.

$$\tan \theta_{5.65} = \frac{0.0100 \text{ m}}{0.0300 \text{ m}}$$

$$\theta_{5.65} = 18.435^\circ$$

$$\tan \theta_{-15.12} = \frac{0.0200 \text{ m}}{0.0100 \text{ m}}$$

$$\theta_{-15.12} = 63.435^\circ$$

We must now write each of the electric forces as a vector in component form. For the 5.65- μC particle, the force is repulsive and will result in positive x and y components.

$$F_{5.65} = (8.99 \times 10^9 \text{ N} \cdot \text{m}^2 / \text{C}^2) \frac{(5.65 \times 10^{-6} \text{ C})(10.33 \times 10^{-6} \text{ C})}{(1.00 \times 10^{-3} \text{ m})^2} \cos(18.435^\circ) \mathbf{i} + \sin(18.435^\circ) \mathbf{j}$$

$$F_{5.65} = (498\mathbf{i} + 166\mathbf{j}) \text{ N}$$

For the $-15.12\text{-}\mu\text{C}$ particle, the force is attractive and will result in a negative x and y components. We retain extra digits for the application of the significant figure rules when later computing the net force.

$$F_{-15.12} = \left(8.99 \times 10^9 \text{ N} \cdot \text{m}^2 / \text{C}^2 \right) \frac{\left| (-15.12 \times 10^{-6} \text{ C})(10.33 \times 10^{-6} \text{ C}) \right|}{5.00 \times 10^{-4} \text{ m}^2} - \cos(63.435^\circ) \hat{i} - \sin(63.435^\circ) \hat{j}$$

$$F_{-15.12} = (-1.256 \times 10^{-3} \hat{i} - 2.512 \times 10^{-3} \hat{j}) \text{ N}$$

10

The net electric force is then found using the principle of superposition.

$$F_{\text{net}} = (498 \hat{i} + 166 \hat{j}) \times 10^{-6} \text{ N} + (-1.256 \hat{i} - 2.512 \hat{j}) \times 10^{-3} \text{ N} = (-758 \hat{i} - 2.35 \times 10^{-3} \hat{j}) \text{ N}$$

40. The magnitude of the force due to the 3.00 nC charge can be calculated with Coulomb's law (Eq. 23.3) and points in the positive x direction.

$$F = k \frac{q_1 q_2}{r^2} = \frac{(8.99 \times 10^9) (5.50 \times 10^{-9} \text{ C})(3.00 \times 10^{-9} \text{ C})}{(0.120 \text{ m})^2} = 1.03 \times 10^{-5} \text{ N}$$

The force due to the -2.50 nC charge is

$$F = k \frac{q_1 q_2}{r^2} = \frac{(8.99 \times 10^9) (-5.50 \times 10^{-9} \text{ C})(-2.50 \times 10^{-9} \text{ C})}{(0.120 \text{ m})^2} = 8.58 \times 10^{-6} \text{ N}$$

which is at an angle of 60 degrees below the $-x$ axis. The net force is then

$$F_x = -(8.58 \times 10^{-6} \text{ N}) \cos 60^\circ + 1.03 \times 10^{-5} \text{ N} = 6.01 \times 10^{-6} \text{ N}$$

$$F_y = -(8.58 \times 10^{-6} \text{ N}) \sin 60^\circ = -7.43 \times 10^{-6} \text{ N}$$

$$F = (6.01 \times 10^{-6} \text{ N}) \hat{i} - (7.43 \times 10^{-6} \text{ N}) \hat{j}$$

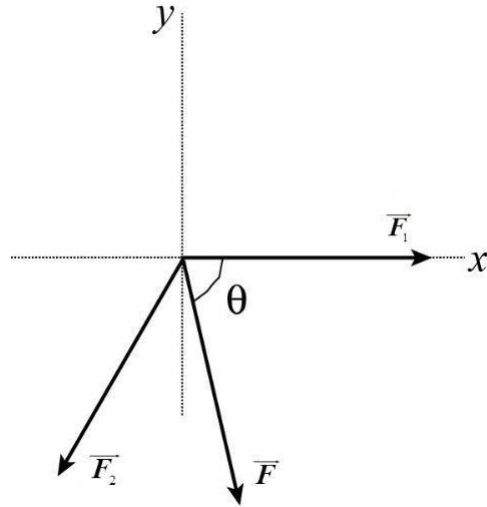

Figure P23.40ANS

41. First, we calculate the magnitudes of each force:

$$F_{AB} = k \frac{|q_A q_B|}{r_{AB}^2} = 8.99 \times 10^9 \frac{\text{N} \cdot \text{m}^2}{\text{C}^2} \frac{(4.00 \times 10^{-9} \text{ C})(2.40 \times 10^{-9} \text{ C})}{(1.00 \text{ m})^2} = 8.63 \times 10^{-8} \text{ N}$$

$$F_{AC} = k \frac{|q_A q_C|}{r_{AC}^2} = 8.99 \times 10^9 \frac{\text{N} \cdot \text{m}^2}{\text{C}^2} \frac{(4.00 \times 10^{-9} \text{ C})(5.30 \times 10^{-9} \text{ C})}{(3.50 \text{ m})^2} = 1.56 \times 10^{-8} \text{ N}$$

$$F_{BC} = k \frac{|q_B q_C|}{r_{BC}^2} = 8.99 \times 10^9 \frac{\text{N} \cdot \text{m}^2}{\text{C}^2} \frac{(5.30 \times 10^{-9} \text{ C})(2.40 \times 10^{-9} \text{ C})}{(2.50 \text{ m})^2} = 1.83 \times 10^{-8} \text{ N}$$

(a) The net force on charge A is:

$$F_A = -F_{AB} - F_{AC} = -8.63 \times 10^{-8} \text{ N} - 1.56 \times 10^{-8} \text{ N} = 1.02 \times 10^{-7} \text{ N downward}$$

or $-1.02 \times 10^{-7} \hat{j} \text{ N}$

(b) The net force on charge B is

$$F_B = F_{AB} + F_{BC} = 8.63 \times 10^{-8} \text{ N} + 1.83 \times 10^{-8} \text{ N} = 1.05 \times 10^{-7} \text{ N upward}$$

or $1.05 \times 10^{-7} \hat{j} \text{ N}$

(c) The net force on charge C is

$$F_C = F_{AC} - F_{BC} = 1.55 \times 10^{-8} \text{ N} - 1.83 \times 10^{-8} \text{ N} = 2.74 \times 10^{-9} \text{ N downward}$$

or $-2.74 \times 10^{-9} \hat{j} \text{ N}$

42. (a) When the center sphere is connected with the left, each ends up with half the initial charge on the left conductor ($35.6/2 = 17.8 \text{ nC}$). When the second wire is connected, the charge on the center is redistributed such that it and the conductor on the right each end up with half of this charge ($17.8/2 = 8.90 \text{ nC}$). So, from left to right, they have charges of 17.8 nC , 8.90 nC , and 8.90 nC .

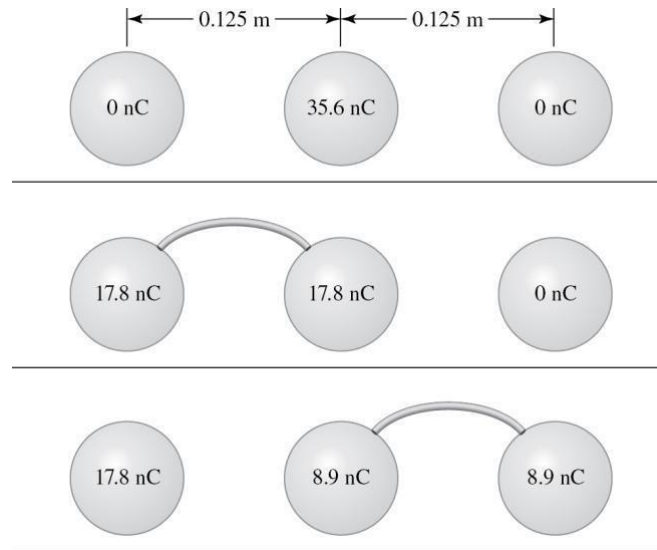

Figure P23.42ANS

(b) Considering the different pairs of conductor, the force between the left and center conductors is the largest. The conductor on the left experiences this force to the left due to the center conductor as well as a smaller force to the left due to the charge on the right. These reinforce each other, so the conductor on the left experiences the largest net force.

(c) Apply Coulomb's law (Eq. 23.3) for the force on the left hand charge due to the middle and the right. As discussed in part (b), since all charges are positive, both forces on the conductor on the left point to the left, and therefore, their magnitudes add.

$$F_{ML} = \left(\frac{8.99 \times 10^9 \text{ N} \cdot \text{m}^2 / \text{C}^2} \right) \frac{(17.8 \times 10^{-9} \text{ C})(8.90 \times 10^{-9} \text{ C})}{(0.125 \text{ m})^2} = 9.12 \times 10^{-5} \text{ N}$$

$$F_{RL} = \left(\frac{8.99 \times 10^9 \text{ N} \cdot \text{m}^2 / \text{C}^2} \right) \frac{(17.8 \times 10^{-9} \text{ C})(8.90 \times 10^{-9} \text{ C})}{(0.250 \text{ m})^2} = 2.28 \times 10^{-5} \text{ N}$$

$$F_{\text{tot}} = F_{ML} + F_{RL} = 9.12 \times 10^{-5} \text{ N} + 2.28 \times 10^{-5} \text{ N} = 1.14 \times 10^{-4} \text{ N}$$

43. The components of the resultant force are

$$F_x = -F_{AB} = -8.99 \times 10^9 \frac{\text{N} \cdot \text{m}^2}{\text{C}^2} \frac{(5.60 \times 10^{-6} \text{ C})(4.00 \times 10^{-6} \text{ C})}{(0.450 \text{ m})^2} = -9.94 \times 10^{-1} \text{ N} \quad (\text{to the left})$$

$$F_y = -F_{BC} = -8.99 \times 10^9 \frac{\text{N} \cdot \text{m}^2}{\text{C}^2} \frac{(4.00 \times 10^{-6} \text{ C})(2.30 \times 10^{-6} \text{ C})}{(0.280 \text{ m})^2} = -1.05 \text{ N} \quad (\text{downward})$$

The forces are perpendicular, so the magnitude of the resultant is

$$F_R = \sqrt{(F_{AB})^2 + (F_{BC})^2} = 1.45 \text{ N} \quad \boxed{}$$

The angle of the resultant is

$$\theta = \tan^{-1} \frac{F_{BC}}{F_{AB}} = \tan^{-1} \frac{1.05 \text{ N}}{0.994 \text{ N}} = 46.7^\circ$$

The resultant force is in the third quadrant, so the direction is $\boxed{46.7^\circ \text{ below } -x \text{ axis}}$.

44. Set the Coulomb force of attraction equal to the centripetal force acting on the electron, and solve for the speed, v .

$$F_e = \frac{k_e e^2}{r^2} = F_c = \frac{m_e v^2}{r} \rightarrow v = \sqrt{\frac{k_e e^2}{m_e r}}$$

$$v = \sqrt{\frac{(8.99 \times 10^9)(1.6 \times 10^{-19})^2}{(9.11 \times 10^{-31})(5.29 \times 10^{-11})}} = \boxed{2.19 \times 10^6 \text{ m/s}}$$

The frequency can be calculated from the speed and the circumference of the orbit.

$$f = \frac{v}{2\pi r} = \frac{\sqrt{\frac{(8.99 \times 10^9)(1.6 \times 10^{-19})^2}{(9.11 \times 10^{-31})(5.29 \times 10^{-11})}}}{2\pi (5.29 \times 10^{-11})} = \boxed{6.57 \times 10^{15} \text{ Hz}}$$

45. Note that the third charged particle would be repelled by each of the fixed-location particles. Thus, for the net electric force on the third particle to be zero, it must be somewhere between the two other particles.

Express the magnitude of the electric force on the third particle due to each of the other particles separately, where r is the location of the third particle away from the origin, along the positive x axis.

$$F_q = \frac{k|qq|}{r^2}$$

$$F_{2q} = \frac{k|2qq|}{(d-r)^2}$$

2016 Cengage Learning. All rights reserved. May not be scanned, copied or duplicated, or posted to a publicly accessible website, in whole or part.

Because we know these forces must be equal in magnitude and opposite in direction, equate the two forces and solve for r . We choose only the answer that is physically reasonable.

$$\begin{aligned} \frac{k|qq|}{r^2} &= \frac{k|2qq|}{(d-r)^2} \\ \frac{1}{r^2} &= \frac{2}{(d-r)^2} \\ (d-r)^2 &= 2r^2 \\ d^2 - 2dr + r^2 &= 2r^2 \\ r^2 + 2dr - d^2 &= 0 \\ r &= \frac{-2d \pm \sqrt{2d^2 - 4(-d^2)}}{2} = \frac{-2d \pm \sqrt{d^2}}{2} = \frac{-2d \pm \sqrt{2}d}{2} \\ r &= \boxed{\left(\frac{\sqrt{2}-1}{2}\right)d} \end{aligned}$$

46. We apply Coulomb's law (Eq. 23.3). The force due to the particle on the lower left-hand corner is

$$F_1 = \frac{(8.99 \times 10^9)(6.50 \times 10^{-9})^2}{(0.200)^2} = 9.50 \times 10^{-6} \text{ N}$$

The force due to the particle on the upper right-hand corner is

$$F_2 = \frac{(8.99 \times 10^9)(6.50 \times 10^{-9})^2}{(0.800)^2} = 5.93 \times 10^{-7} \text{ N}$$

To find the force due to the particle on the upper left-hand corner, we note that the distance between the particles is given by $\sqrt{(0.800 \text{ m})^2 + (0.200 \text{ m})^2} = 0.825 \text{ m}$. The direction of this force is $\theta = \tan^{-1} \frac{80.0}{20.0} = 76.0^\circ$.

$$F_3 = \frac{(8.99 \times 10^9)(6.50 \times 10^{-9})^2}{(0.825)^2} = 5.59 \times 10^{-7} \text{ N}$$

The components of the net force are then

$$F_x = F_1 + F_3 \cos 76.0^\circ = 9.50 \times 10^{-6} \text{ N} + (5.59 \times 10^{-7} \text{ N}) \cos 76.0^\circ$$

$$F_y = -F_2 - F_3 \sin 76.0^\circ = -5.93 \times 10^{-7} \text{ N} - (5.59 \times 10^{-7} \text{ N}) \sin 76.0^\circ$$

Finally, the magnitude and direction of the net force are

$$F_{\text{net}} = \sqrt{F_x^2 + F_y^2}$$

$$F_{\text{net}} = \sqrt{(9.50 \times 10^{-6} \text{ N} + 5.59 \times 10^{-7} \text{ N} \cos 76.0^\circ)^2 + (-5.93 \times 10^{-7} \text{ N} - 5.59 \times 10^{-7} \text{ N} \sin 76.0^\circ)^2}$$

$$F_{\text{net}} = \boxed{9.70 \times 10^{-6} \text{ N}}$$

$$\varphi = \tan^{-1} \frac{F_y}{F_x} = \tan^{-1} \frac{-5.93 \times 10^{-7} \text{ N} - (5.59 \times 10^{-7} \text{ N}) \sin 76.0^\circ}{9.50 \times 10^{-6} \text{ N} + (5.59 \times 10^{-7} \text{ N}) \cos 76.0^\circ} = \boxed{6.72^\circ \text{ below the } +x \text{ axis}}$$

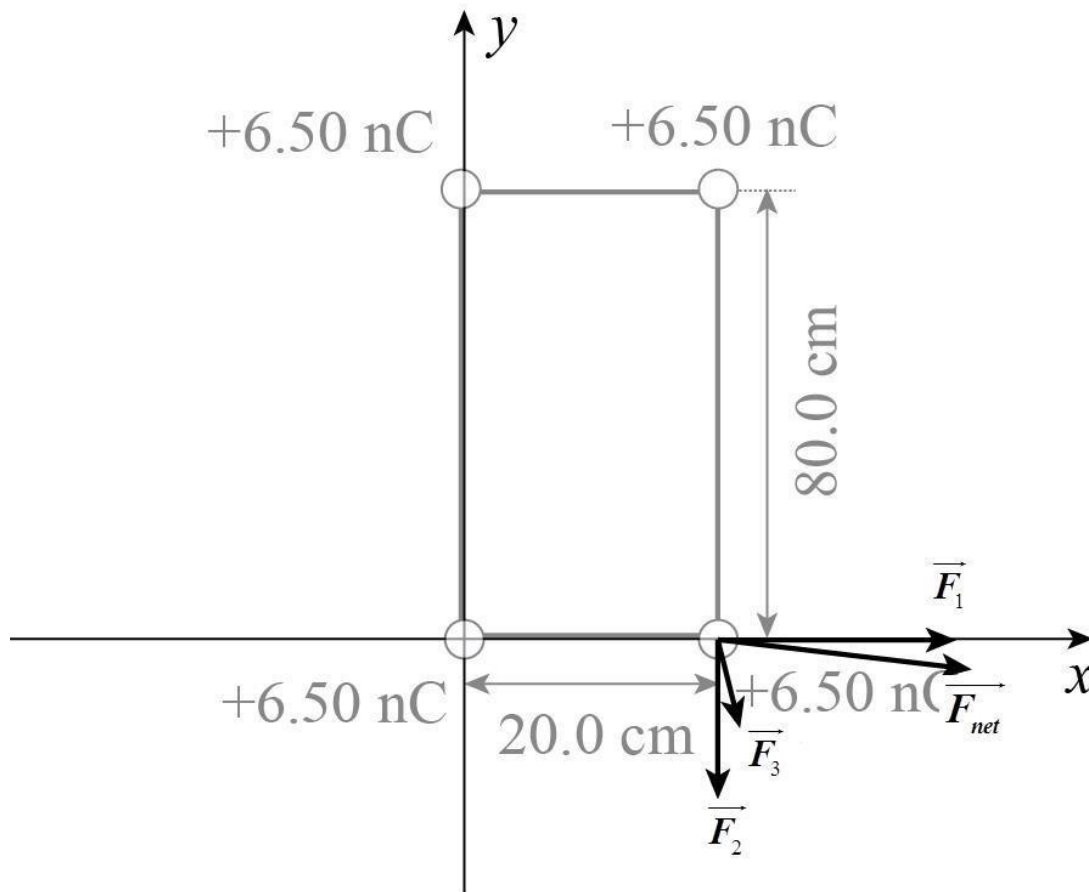

Figure P23.46ANS

47. This is actually an *unstable* equilibrium. However, we assume that it remains directly above the charge on the tabletop, and therefore, only concern ourselves with its vertical position. For the sphere to remain stationary, there must be a repulsive force due to the charge on the tabletop that is equal and opposite the force of gravity on the sphere.

$$mg = k \frac{|q_1 q_2|}{r^2}$$

$$q_2 = \frac{mgr^2}{k q_1} = \frac{(0.00500 \text{ kg})(9.81 \text{ m/s}^2)(0.0500 \text{ m})^2}{(8.99 \times 10^9 \text{ N} \cdot \text{m}^2 / \text{C}^2)(3.00 \times 10^{-8} \text{ C})} = 4.55 \times 10^{-7} \text{ C}$$

48. We model the spheres as particles with different charges. They have equal masses and exert equal and opposite forces on each other, so their strings make equal angles θ with the vertical. The distance r between them is

$$\sin\theta = (r/2)/50.0 \text{ cm} \rightarrow r = (1.00 \text{ m}) \sin\theta$$

Let F_T represent the string tension. We have

$$\Sigma F_x = 0: \quad \frac{k_e q_1 q_2}{r^2} = F_T \sin \theta$$

$$\Sigma F_y = 0: \quad mg = F_T \cos \theta$$

Divide to eliminate F_T :

$$\frac{kq_1 q_2}{r^2 mg} = \tan\theta = \frac{r/2}{\sqrt{(50.0 \text{ cm})^2 - r^2/4}}$$

$$\left(\frac{8.99 \times 10^9}{4.00 \times 10^{-3} \text{ kg} (9.80 \text{ m/s}^2)} \right) \left(\frac{0.800 \times 10^{-6} \text{ C} \cdot 1.50 \times 10^{-6} \text{ C}}{r^2} \right) \sqrt{(100 \text{ cm})^2 - r^2} = mgr^3$$

This gives $13.2035 r^6 + r^2 - 1.00 = 0$. We try to find a solution by testing values.

r	$13.2035 r^6 + r^2 - 1.00$
0	-1.00
0.500	-0.544
0.800	+3.10
0.600	-0.0240
0.610	+0.0523
0.605	+0.0135

0.604	+0.00589
-------	----------

Thus the distance to three digits is $0.604 \text{ m} = \boxed{60.4 \text{ cm}}$.

49. Draw a free body diagram of the hanging sphere. Apply the force conditions of static equilibrium to find the electric force.

$$F_x = F_E - F_T \sin 18^\circ = 0$$

$$F_y = F_T \cos 18^\circ - F_g = 0$$

$$F_E = F_g \tan 18^\circ = mg \tan 18^\circ = (0.004)(9.81) \tan 18^\circ = 0.013 \text{ N}$$

Solve Coulomb's law for the charge needed to produce this electric force. q_2 must be negative, so that the two charges repel. Also $r = (0.20 \text{ m}) \sin 18^\circ = 0.062 \text{ m}$.

$$F = \frac{k q_1 q_2}{r^2}$$

$$|q_2| = \frac{r^2 F}{k |q_1|} = \frac{(0.062)^2 (0.013)}{(8.99 \times 10^9)(3.6 \times 10^{-6})} = 1.5 \times 10^{-9} \text{ C}$$

$$q_2 = \boxed{-1.5 \times 10^{-9} \text{ C}}$$

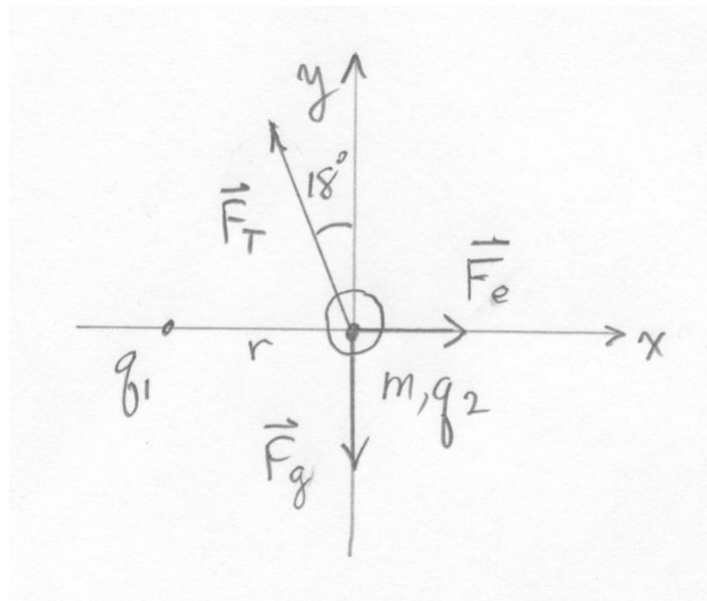

Figure P23.49ANS

50. (a) They must be the same charge.

(b) The net force on each sphere due to the string tension, electrostatic force, and gravity is zero.

$$F_x = 0: k \frac{q^2}{r^2} - F_T \sin \phi = 0$$

$$F_y = 0: F_T \cos \phi - mg = 0$$

Using the y component,

$$F_T = \frac{mg}{\cos \phi} = \frac{(0.350 \times 10^{-3} \text{ kg})(9.81 \text{ m/s}^2)}{\cos 23.4^\circ} = \boxed{3.74 \times 10^{-3} \text{ N}}$$

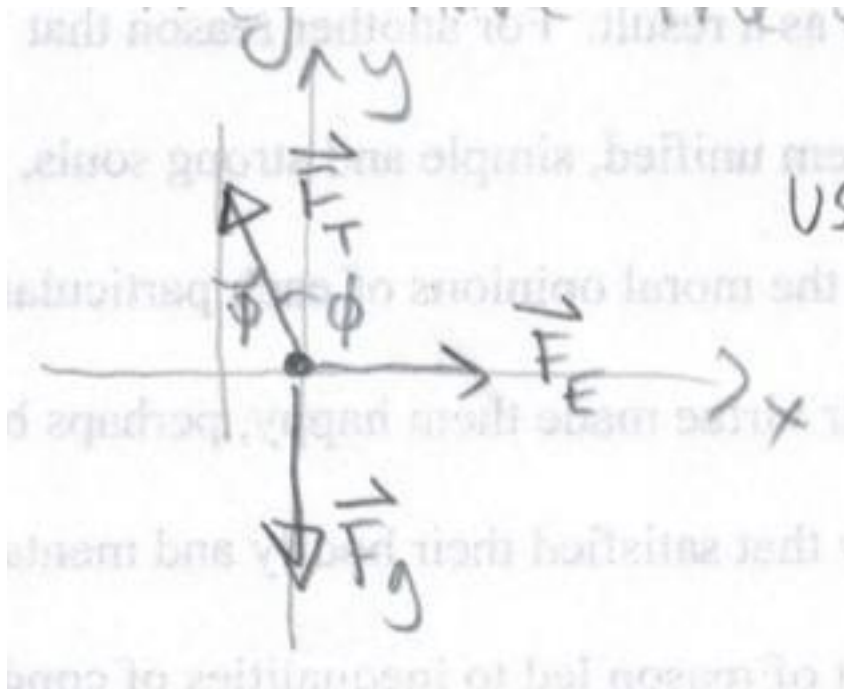

Figure P23.50ANS

(c) The separation between the charges is found using geometry.

$$r = 0.500 \text{ m} + 2(0.750 \text{ m}) \sin 23.4^\circ = 1.096 \text{ m}$$

Using the x component from part (b),

$$q = \sqrt{\frac{r^2 F_T \sin \phi}{k}} = \sqrt{\frac{1.096 \text{ m}^2 (3.74 \times 10^{-3} \text{ N}) \sin 23.4^\circ}{8.99 \times 10^9 \text{ N} \cdot \text{m}^2 / \text{C}^2}} = \boxed{4.45 \times 10^{-7} \text{ C}}$$

51. Given the symmetry, the center charge necessarily experiences equal and opposite forces due to the charges at the four corners and is therefore in static equilibrium. We now consider one of the corner charges to determine when it would be in equilibrium. We label the charges as shown, assuming all charges are positive, and consider the net force on Charge 4. Note that the distance from Charges 1 and 3 is L , from Charge 2 is $2\sqrt{L}$, and the distance to Charge 5 is half that, $\sqrt{L}/2$.

$$F_1 = k \frac{q^2}{L^2} \hat{i}$$

$$F_2 = k \frac{q^2}{(\sqrt{2}L)^2} \left(\frac{\sqrt{2}}{2} \hat{i} + \frac{\sqrt{2}}{2} \hat{j} \right)$$

$$F_3 = k \frac{q^2}{L^2} \hat{j}$$

$$F_5 = k \frac{qQ}{(\frac{\sqrt{L}}{2})^2} \left(\frac{\sqrt{2}}{2} \hat{i} + \frac{\sqrt{2}}{2} \hat{j} \right)$$

Now, for static equilibrium, the net force must be zero. For the x component:

$$F_x = k \frac{q^2}{L} + k \frac{\sqrt{2}q^2}{4L} + k \frac{\sqrt{2}qQ}{L} = 0$$

$$q + \frac{\sqrt{2}}{4} q + \sqrt{2} Q = 0$$

$$Q = - \frac{1}{\sqrt{2}} - \frac{1}{4} q = \boxed{-q \frac{1+2\sqrt{2}}{4}}$$

The same result is found by considering the y components.

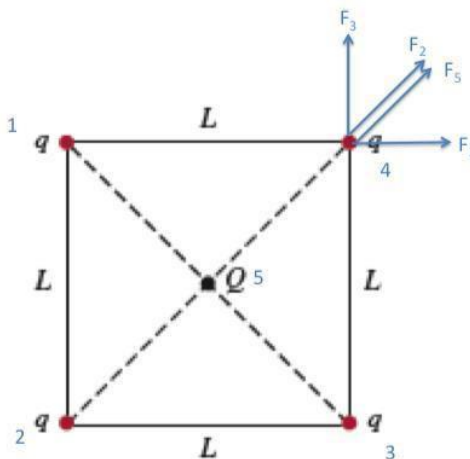

Figure P23.51ANS

52. All four forces are equal in magnitude, $|F_1| = |F_2| = |F_3| = |F_4| = k \frac{qQ}{a^2}$, where a is the length of half the diagonal. Regardless of the sign of Q , F_2 cancels F_4 and F_1 cancels F_3 . Thus, the net force on charge Q is zero and it is in static equilibrium.

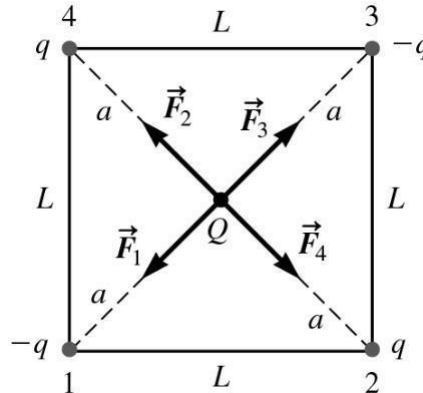

Figure P23.52ANS

53. Let the bead have charge Q and be located distance d from the left end of the rod. This bead will experience a net force given by

$$F = \frac{k(8.00 \text{ nC})Q}{d^2} \hat{i} + \frac{k(2.00 \text{ nC})Q}{(2.00 \text{ m} - d)^2} (-\hat{i})$$

The net force will be zero if $\frac{4.00}{d^2} = \frac{1}{(2.00 \text{ m} - d)^2}$, or $2.00 \text{ m} - d = \frac{d}{2}$.

This gives an equilibrium position of the bead of $d = 1.33 \text{ m}$ from the 8.00-nC sphere.

54. Note that the third charged particle would be repelled by one of the fixed-location particles and attracted by the other. Thus, for the net electric force on the third particle to be zero, it must not be between the two other particles. Because the particle at the origin has a lesser magnitude of charge, we expect the third particle would experience no net electric force if it were to the left of this particle, or somewhere along the $-x$ axis.

Express the magnitude of the electric force on the third particle due to each of the other particles separately, where r is the location of the third particle away from the origin, along the negative x axis.

$$F_q = \frac{k|qq|}{r^2}$$

$$F_{-2q} = \frac{k|-2qq|}{(d-r)^2}$$

Because we know these forces must be equal in magnitude and opposite in direction, equate the two forces and solve for r . We choose only the answer that is physically reasonable.

$$\frac{k|qq|}{r^2} = \frac{k|-2qq|}{(d-r)^2}$$

$$\frac{1}{r^2} = \frac{2}{(d-r)^2}$$

$$(d-r)^2 = 2r^2$$

$$d^2 - 2dr + r^2 = 2r^2$$

$$r^2 + 2dr - d^2 = 0$$

$$r = \frac{-2d \pm \sqrt{2d^2 - 4d^2}}{2} = \frac{-2d \pm 8\sqrt{d^2}}{2} = \frac{2d \pm 2\sqrt{d}}{2}$$

$$r = \boxed{(-\sqrt{2}-1)d}$$

Note, only the negative root is used in the answer, as the positive root is not applicable.

55. The three charges are in static equilibrium, so the net force on each is zero. Considering the sphere on the right,

$$\Sigma F_y = 0 : F_T \cos \theta = mg \rightarrow \frac{F_T}{mg} = \frac{mg}{\cos \theta}$$

$$\Sigma F_x = 0 : F_E = F_T \sin \theta = \frac{mg \sin \theta}{\cos \theta} = mg \tan \theta \quad (1)$$

We can also calculate the Coulomb force (Eq.23.3) on this rightmost charge due to the charges on the left and the center. The charges are all the same, and the distances between them can be found using geometry.

$$F_r = \frac{kq^2}{r_1^2} + \frac{kq^2}{r^2} = \frac{kq^2}{(L \sin \theta)^2} + \frac{kq^2}{(2L \sin \theta)^2} = \frac{5kq^2}{4L^2 \sin^2 \theta} \quad (2)$$

Equating equations (1) and (2), we solve for q .

$$q = \sqrt{\frac{4L^2 mg \tan \theta \sin^2 \theta}{5k}}$$

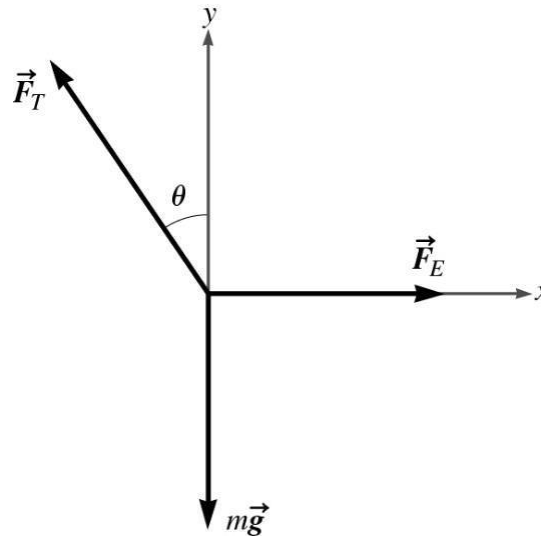

Figure P23.55ANS

56. The balloon induces dipoles in the atoms of the ceiling. Since the charge is then closer to the opposite charge in the induced dipole, there is a net attraction.

$$57. N = 1.00 \text{ g} \times \frac{1 \text{ mol}}{55.845 \text{ g}} \times 6.022 \times 10^{23} \frac{\text{atoms}}{\text{mol}} \times \frac{26 \text{ electrons}}{\text{atom}} = \boxed{2.80 \times 10^{25} \text{ electrons}}$$

58. (a) The two ions are both doubly charged, $\pm 2e$, one positive and one negative. Thus, using Coulomb's law (Eq. 23.3),

$$F = k \frac{|q_1 q_2|}{r^2} = \frac{k 4e^2}{(0.680 \text{ m})^2} = \frac{4(8.99 \times 10^9 \text{ N} \cdot \text{m}^2 / \text{C}^2)(1.60 \times 10^{-19} \text{ C})^2}{(0.680 \text{ m})^2} = \boxed{1.99 \times 10^{-9} \text{ N}}$$

(b) The electric force depends only on the magnitudes of the two charges, and the distance between them, and would not change if the nickel ion was replaced with an iron ion, since both are doubly ionized.

59. The negative charge, call it Q , is $80.0\text{ cm} - 62.0\text{ cm} = 18.0\text{ cm}$ from charge q . The force on Q from the $2.25\ \mu\text{C}$ charge balances the force on Q from the $+q$ charge:

$$\frac{k(2.25 \mu\text{C})Q}{(0.620 \text{ m})^2} = \frac{kQq}{(0.180 \text{ m})^2} \rightarrow q = 2.25 \mu\text{C} \frac{0.180^2}{0.620} = \boxed{1.90 \times 10^{-7} \text{ C}}$$

60. Apply Coulomb's law (Eq. 23.3), to calculate the distance r , given the charges and the magnitude of the force.

$$r = \sqrt{\frac{k|q_1q_2|}{F_E}} = \sqrt{\frac{8.99 \times 10^9 \text{ N} \cdot \text{m}^2 / \text{C}^2}{(3 \text{ N})} \frac{5 \times 10^{-6} \text{ C} \cdot 2 \times 10^{-6} \text{ C}}{}}$$

After the conductors are brought into contact, the net charge of $5 \mu\text{C} - 2 \mu\text{C} = 3 \mu\text{C}$ is split evenly between them, so they each have $1.5 \mu\text{C}$. We can now calculate the force.

$$F_E = k \frac{|q_1q_2|}{r^2}$$

$$F_E = (8.99 \times 10^9 \text{ N} \cdot \text{m}^2 / \text{C}^2) \frac{(1.5 \times 10^{-6} \text{ C})(1.5 \times 10^{-6} \text{ C})}{(0.620 \text{ m})^2} = \boxed{0.675 \text{ N}}$$

61. Using Eq. 23.3, we apply Coulomb's law. The force due to Charge B is attractive and points in the positive x direction.

$$F_B = \frac{kq_Aq_B}{d^2} \hat{i} = \frac{(8.99 \times 10^9)(6.40 \times 10^{-6} \text{ C})(2.30 \times 10^{-6} \text{ C})}{(0.200 \text{ m})^2} \hat{i} = (3.31 \text{ N})\hat{i}$$

The force due to Charge C points 45 degrees below the negative x axis.

$$F_C = \frac{kq_Aq_C}{(\sqrt{2}d)^2} (-\hat{i} - \hat{j}) = \frac{(8.99 \times 10^9)(6.40 \times 10^{-6} \text{ C})(3.80 \times 10^{-6} \text{ C})}{(\sqrt{2}(0.200 \text{ m}))^2} (-\hat{i} - \hat{j}) = (1.93 \text{ N})(-\hat{i} - \hat{j})$$

The net force is then

$$F_1 + F_2 = (3.31 \text{ N})\hat{i} + (1.93 \text{ N})(-\hat{i} - \hat{j}) = \boxed{(1.38 \hat{i} - 1.93 \hat{j}) \text{ N}}$$

62. Calculate the ratio using Coulomb's law:

$$\frac{F_A}{F_B} = \frac{k \frac{q^2}{(D)^2}}{k \frac{q^2}{(D+D)^2}} = \frac{1}{4}$$

As indicated in the text, the charged object will cause the electrons in the conductor to move away from it if it is negative, or towards it if positive, thus creating an attractive force between the object and the conductor.

63. (a) Use Coulomb's law to find the magnitudes of the two forces acting on the third charge. F_{13} is in the positive x direction (repulsive), and F_{23} is in the negative x direction (attractive).

$$F_{13} = k \frac{q_1 q_3}{r_{13}^2} = (8.99 \times 10^9) \frac{(4.00 \times 10^{-6})(2.00 \times 10^{-6})}{(0.05)^2} = 28.77 \text{ N}$$

$$F_{23} = k \frac{q_2 q_3}{r_{23}^2} = (8.99 \times 10^9) \frac{(1.00 \times 10^{-6})(2.00 \times 10^{-6})}{(0.05 - 0.02)^2} = 19.98 \text{ N}$$

$$F_{net} = (28.77 - 19.98) \hat{i} = 8.79 \text{ N}$$

(b) The two original charges have been replaced by a single point charge with the same net charge.

$$F = k \frac{q_{net} q_3}{r^2} \hat{i} = (8.99 \times 10^9) \frac{(3.00 \times 10^{-6})(2.00 \times 10^{-6})}{(0.05)^2} \hat{i} = 21.6 \hat{i} \text{ N}$$

In this case, the distance to the third charge is comparable to the separation, and we can't simply replace the first two with an effective charge at the origin.

64. The toughest part is estimating the weight of the hair. For instance, assume several strands of hair is about 2 g (the mass of a paperclip) and that the distance is around an inch (or 3 cm). Taking the Coulomb force as equal in magnitude to the weight and

assuming a point charge model, we calculate a charge of around 40 nC. Estimates could vary based on the assumptions made.

65. The forces acting on each sphere are tension, electrostatic (Coulomb), and gravitational. Since the sphere is in static equilibrium, the net force is zero. Considering the vertical component first,

$$F_T \cos\theta = mg$$

$$F = \frac{mg}{\cos\theta} \quad (1)$$

Now, using the horizontal components and substituting Equation (1),

$$F_E = F_T \sin\theta$$

$$F_E = mg \tan\theta$$

At equilibrium, the distance separating the two spheres is $r = 2L \sin\theta$. We can then use Coulomb's law (Eq. 23.3) to express the electric force between the two charges q .

$$\frac{kq^2}{(2L \sin\theta)^2} = mg \tan\theta$$

$$m = \frac{kq^2}{4L^2 g \tan\theta \sin^2\theta}$$

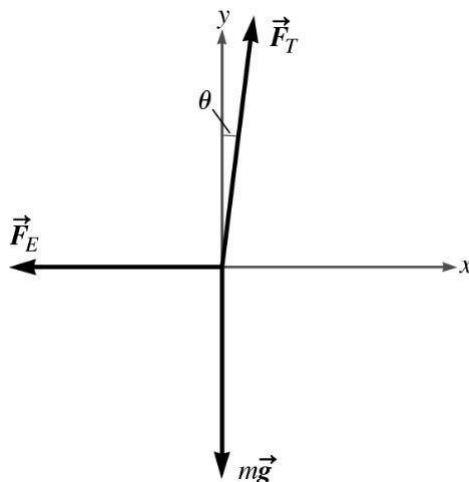

Figure P23.65ANS

66. (a) There are four forces acting on each balloon: gravitational force due to its weight, electrostatic repulsive force, tension in the string, and the buoyant force. Three forces are

acting on the hanging mass: gravitational force and the tension of each string. The net force is zero on each object. Using trigonometry, we determine the angle, θ . In triangle ABC,

$$\sin\theta = \frac{AD}{AC} = \frac{0.30}{1.0} = 0.3 \rightarrow \theta = \sin^{-1}(0.3) = 17.5^\circ$$

$$\cos\theta = 0.954$$

First, consider the hanging mass to determine the tension of each string:

$$F_y = 0$$

$$2T \cos\theta = mg$$

$$T = \frac{mg}{2 \cos\theta} = \frac{(5.0 \times 10^{-3} \text{ kg})(9.81 \text{ m/s}^2)}{2(0.954)} = 0.026 \text{ N}$$

Now, consider Balloon A on the left side:

$$\mathbf{F} = \mathbf{T} + \mathbf{F}_g + \mathbf{F}_E + \mathbf{F}_b$$

$$F = T \sin\theta \hat{i} - T \cos\theta \hat{j} + (-m_1 g \hat{j}) + (-k \frac{q^2}{r^2} \hat{i}) + (1.29 \text{ kg/m}^3) V g \hat{j} = 0$$

$$F = T \sin\theta - k \frac{q^2}{r^2} + (-T \cos\theta - m_1 g + (1.29 \text{ kg/m}^3) V g) \hat{j} = 0 \tag{1}$$

where m_1 is the mass of the helium in the balloon (ignoring the balloon itself), V is the volume of air displaced, and the buoyant force is $\rho_{\text{air}} V g$. Using the fact that the x components of the forces must add to zero and $T = 0.026 \text{ N}$ and $r = 0.60 \text{ m}$,

$$T \sin\theta = k \frac{q^2}{r^2} \rightarrow q = r \sqrt{\frac{T \sin\theta}{k}}$$

$$q = (0.60 \text{ m}) \sqrt{\frac{(0.026 \text{ N})(0.3)}{(8.99 \times 10^9 \text{ N} \cdot \text{m}^2/\text{C}^2)}} = \boxed{5.6 \times 10^{-7} \text{ C}} = 0.56 \text{ nC}$$

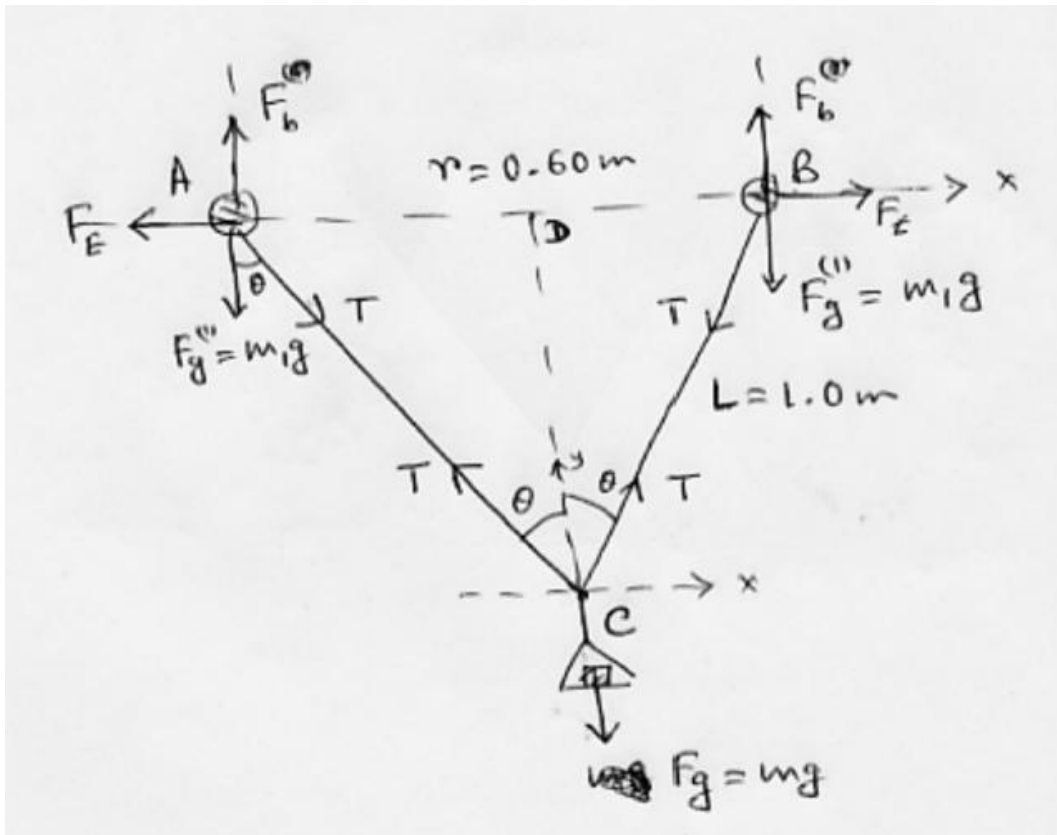

Figure P23.66ANS

(b) Now, consider the y component in Equation (1) in Part (a). The mass of helium is $m_1 = \rho_{\text{He}}V$.

$$T \cos \theta + m_1 g = (1.29 \text{ kg/m}^3)Vg$$

$$(0.026 \text{ N})(0.954) + (0.200 \text{ kg/m}^3)Vg = (1.29 \text{ kg/m}^3)Vg$$

$$V = \frac{0.0248 \text{ N}}{(1.29 - 0.200) \text{ kg/m}^3 \cdot 9.81 \text{ m/s}^2} = \boxed{2.3 \times 10^{-3} \text{ m}^3}$$

67. Three forces are acting on each sphere: gravitational force, electrostatic force, and tension in the string as shown for Sphere A. The net force on the sphere is zero:

$$F = T \sin 30^\circ - k \frac{q^2}{r^2} + (T \cos 30^\circ - mg)j = 0$$

Considering each component separately,

$$T \sin 30^\circ = k \frac{q^2}{r^2} \tag{1}$$

$$T \cos 30^\circ = mg \tag{2}$$

Dividing equation (1) by (2) and solving for q ,

$$\frac{\tan 30^\circ}{1} = \frac{kq^2}{mgr}$$

$$q = \pm \sqrt{\frac{mg \tan 30^\circ}{k}} r$$

$$q = \pm 0.10 \text{ m} \sqrt{\frac{2.00 \times 10^{-3} \text{ kg} \cdot 9.81 \text{ m/s}^2 \tan 30^\circ}{(8.99 \times 10^9 \text{ N} \cdot \text{m}^2/\text{C}^2)}}$$

$$q = \boxed{1.12 \times 10^{-7} \text{ C}}$$

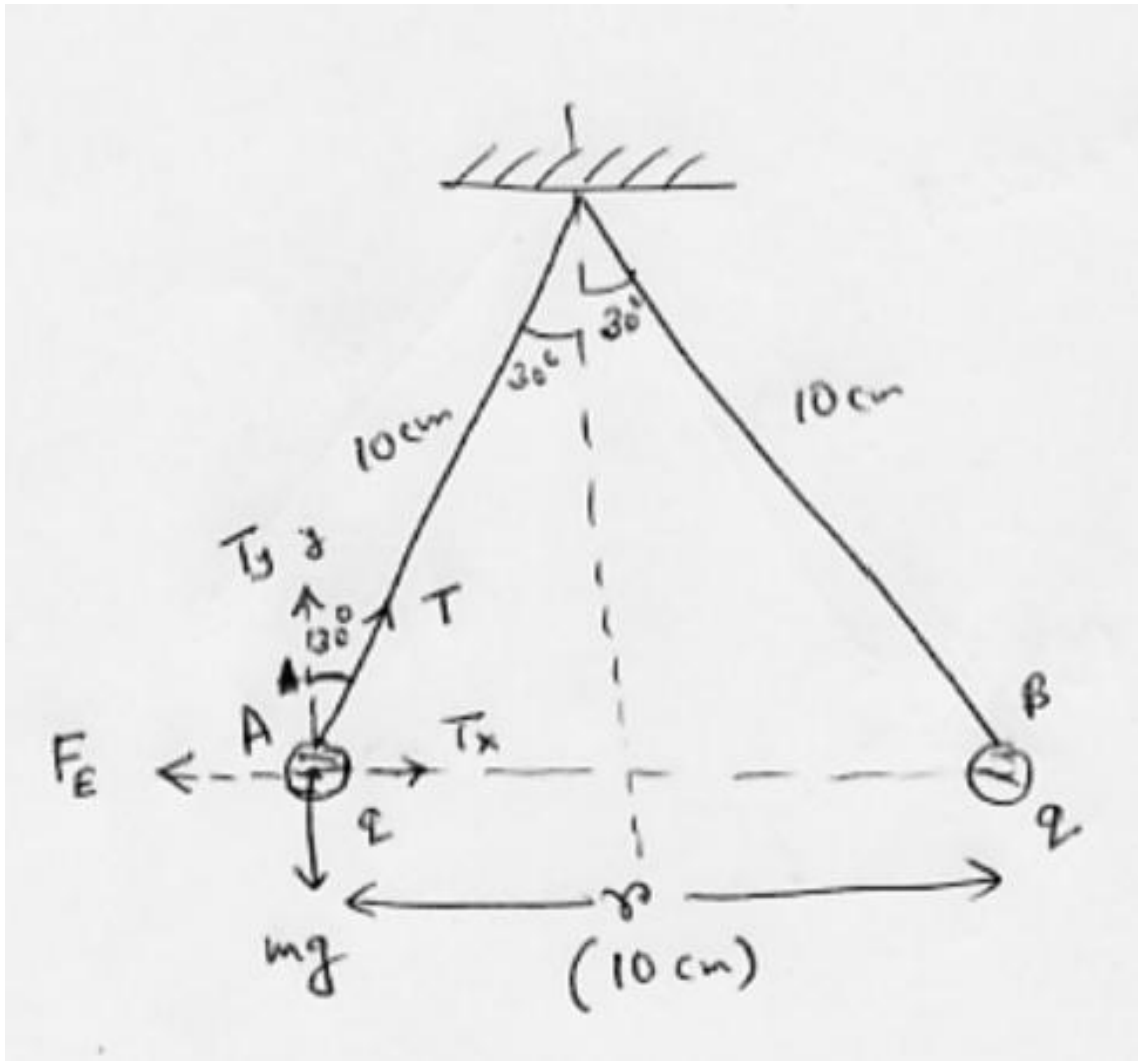

Figure P23.67ANS

68. The third sphere is in static equilibrium, so the forces due to the other charges are equal and opposite.

$$k \frac{|q_1 Q|}{r_1^2} = k \frac{|q_2 Q|}{r_2^2} \rightarrow \frac{q_1}{r_1^2} = \frac{q_2}{r_2^2}$$

Based on the figure,

$$r_1 = x_0 \text{ and } r_2 = L - x_0$$

$$\frac{q}{(x_0)^2} = \frac{q}{(L - x_0)^2} \rightarrow \frac{L - x_0}{x_0} = \sqrt{\frac{q}{q_1}} \rightarrow x = L \sqrt{\frac{q}{q_1} + 1}$$

Finally inserting $q_1 = 4e$ and $q_2 = e$.

$$x_0 = L \sqrt{\frac{e}{4e} + 1} = \frac{2}{3} L$$

The third charged sphere is closer to the sphere with the smaller charge, as we would expect.

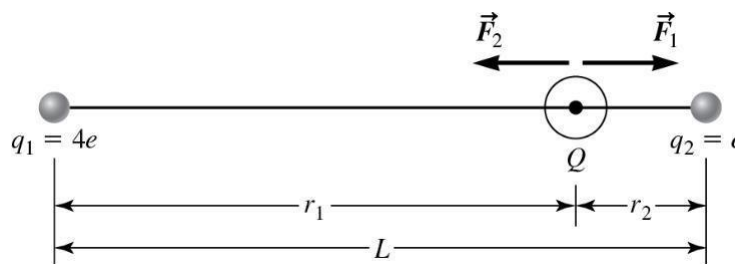

Figure P23.68ANS

69. Charge q resides on each of the blocks, which repel as point charges. We use Coulomb's law (Eq. 23.3) and Hooke's law (with spring constant, K):

$$F = \frac{kq^2}{x^2} = K(x - x_0)$$

Solving for q , we find

$$q = x \sqrt{\frac{K(x - x_0)}{k}} = 0.480 \text{ m} \sqrt{\frac{145 \text{ N/m} \cdot 0.480 \text{ m} - 0.340}{8.99 \times 10^9 \text{ N} \cdot \text{m}^2 / \text{C}^2}} = 2.28 \cdot 10^{-5} \text{ C}$$

70. Considering the forces on Charge C,

$$F_x = F_B - F_T \sin 30^\circ = 0$$

$$F_y = F_A + F_T \cos 30^\circ - F_g = 0$$

Using the first equation,

$$k \frac{q_B q_1}{r_B^2} = F_T \sin 30^\circ = 0$$

$$q_1 = \frac{r_B^2 F_T \sin 30^\circ}{k q_B} = \frac{(0.46 \text{ m})^2 (0.24 \text{ N}) 0.5}{(8.99 \times 10^9 \text{ N} \cdot \text{m}^2 / \text{C}^2)(28 \times 10^{-9} \text{ C})} = \boxed{1.01 \times 10^{-4} \text{ C}}$$

$$k q_B = (8.99 \times 10^9 \text{ N} \cdot \text{m}^2 / \text{C}^2)(28 \times 10^{-9} \text{ C})$$

71. Static equilibrium will occur when the electric force of attraction is equal in magnitude to the weight of the lower sphere.

$$F_E = k \frac{|q_1 q_2|}{r^2} = mg = (0.040)(9.81) = 0.39 \text{ N}$$

$$r = \sqrt{\frac{k |q_1 q_2|}{F_E}} = \sqrt{\frac{(8.99 \times 10^9)(2.0 \times 10^{-6})(1.0 \times 10^{-6})}{0.39}} = \boxed{0.21 \text{ m}}$$

72. First, we find the magnitude of the repulsive force F_1 on charge $q_3 = 0.50 \text{ } \mu\text{C}$, due to charge $q_1 = 1.0 \text{ } \mu\text{C}$.

$$F_1 = (8.99 \times 10^9 \text{ N} \cdot \text{m}^2 / \text{C}^2) \frac{(1.0 \times 10^{-6} \text{ C})(0.50 \times 10^{-6} \text{ C})}{(0.10 \text{ m})^2}$$

The vector force is then

$$F_1 = (8.99 \times 10^9 \text{ N} \cdot \text{m}^2 / \text{C}^2) \frac{(1.0 \times 10^{-6} \text{ C})(0.50 \times 10^{-6} \text{ C})}{(0.10 \text{ m})^2} \cos 60^\circ \hat{i} - \sin 60^\circ \hat{j}$$

The magnitude of the attractive force F_2 is the same as F_1 , since the magnitude of the charges and their separation are the same.

$$\frac{(1.0 \times 10^{-6} \text{ C})(0.50 \times 10^{-6} \text{ C})}{\text{Therefore,}}$$

$$k = -\left(8.99 \times 10^9 \frac{\text{N} \cdot \text{m}^2}{\text{C}^2}\right) \left(0.10 \text{ m}\right)^2 \hat{i}$$

$$F_{\text{tot}} = F_1 + F_2 = \frac{(8.99 \times 10^9 \text{ N} \cdot \text{m}^2 / \text{C}^2) (1.0 \times 10^{-6} \text{ C})(0.50 \times 10^{-6} \text{ C})}{(0.10 \text{ m})^2} (-1 + \cos 60^\circ) \mathbf{i} - \sin 60^\circ \mathbf{j}$$

$$F_{\text{tot}} = (-0.22 \mathbf{i} - 0.39 \mathbf{j}) \text{ N}$$

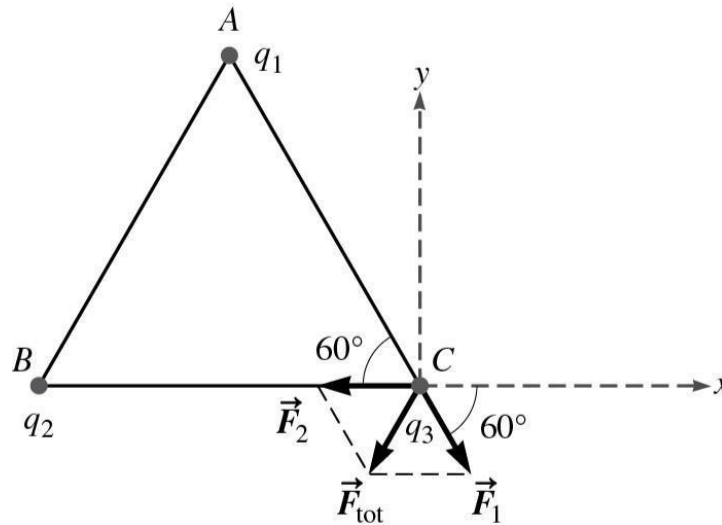

Figure P23.72ANS

73. (a) By symmetry, the x components of the two forces are equal and opposite, so the net force will be the sum of the y components.

$$F_y = F \cos \theta + F \cos \theta = \frac{2kQq}{r^2} \cos \theta$$

Using the Pythagorean theorem,

$$r = \sqrt{h^2 + a^2}$$

and

$$\cos \theta = \frac{h}{r} = \frac{h}{\sqrt{h^2 + a^2}}$$

Therefore,

$$F_y = \frac{2kQq}{h^2 + a^2} \frac{h}{\sqrt{h^2 + a^2}} = \frac{2kQqh}{(h^2 + a^2)^{3/2}}$$

As a vector,

$$\mathbf{F} = \frac{2kQqh}{(h^2 + a^2)^{3/2}} \mathbf{j}$$

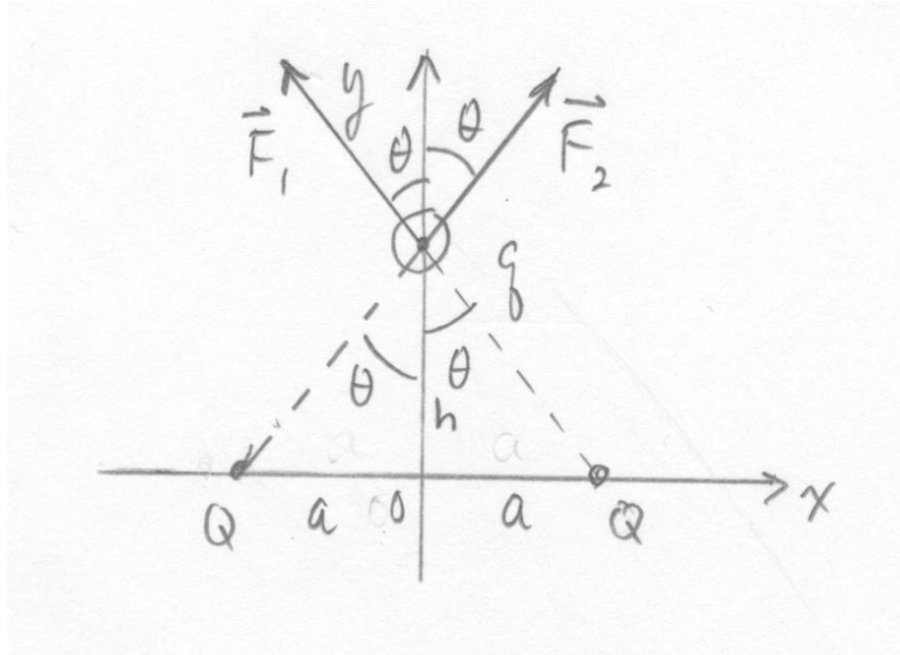

Figure P23.73ANS

(b) When $h \gg a$, the a^2 term in the denominator will be negligible.

$$F = \frac{2kQqh}{(h^2 + a^2)^{3/2}} \approx \frac{2kQqh}{h^3} = \frac{k(2Q)q}{h^2}$$

The result is equivalent to charges q and $2Q$, separated by a distance, h .

74. (a) To find the maximum, we set the derivative equal to zero.

$$\frac{dF_y}{dy} = \frac{(y^2 + a^2)^{-3/2} \cdot 2kQq - 2kQqy \cdot \frac{3}{2}(y^2 + a^2)^{-5/2} \cdot 2y}{(y^2 + a^2)^3} = 0$$

$$(y^2 + a^2)^{-3/2} = 3y^2(y^2 + a^2)^{-5/2}$$

$$y^2 + a^2 = 3y^2$$

$$y = \pm \frac{a}{\sqrt{2}}$$

(b)

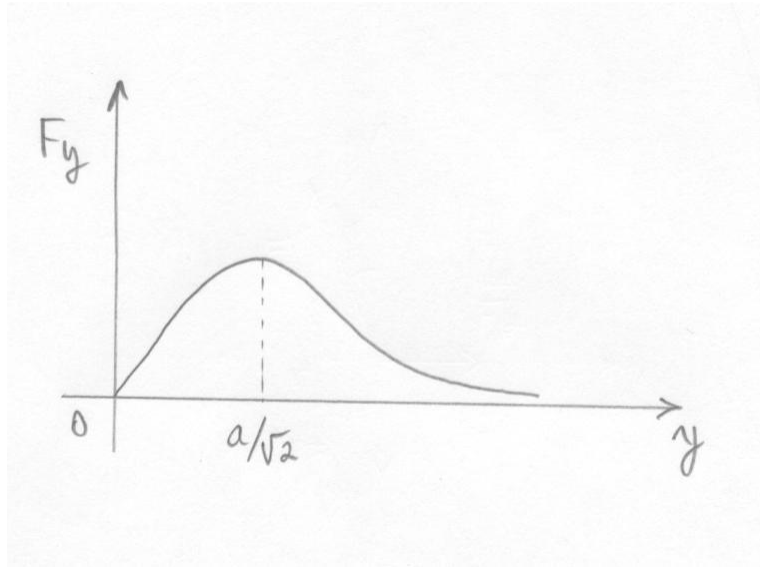

Figure P23.74ANS

75. We use unit vectors to find the total electric force on Sphere A, produced by the seven other spheres:

Source Charge	Force
(1) Sphere B:	$F_{BA} = -\frac{kq^2}{d^2} \hat{j}$
(2) Sphere C:	$F_{CA} = -\frac{kq^2}{(d+d)^2} \hat{i} - \frac{kq^2}{(d+d)^2} \hat{j}$
(3) Sphere D:	$F_{DA} = -\frac{kq^2}{d^2} \hat{i}$
(4) Sphere E:	$F_{EA} = -\frac{kq^2}{d^2} \hat{k}$
(5) Sphere F:	$F_{FA} = -\frac{kq^2}{(d+d)^2} \hat{j} - \frac{kq^2}{(d+d)^2} \hat{k}$
(6) Sphere G:	$F_{GA} = -\frac{kq^2}{\sqrt{d^2+d^2}} \hat{i} - \frac{kq^2}{\sqrt{d^2+d^2}} \hat{j} - \frac{kq^2}{\sqrt{d^2+d^2}} \hat{k}$
(7) Sphere H:	$F_{HA} = -\frac{kq^2}{(d+d)^2} \hat{i} - \frac{kq^2}{(d+d)^2} \hat{j} - \frac{kq^2}{(d+d)^2} \hat{k}$

2016 Cengage Learning. All rights reserved. May not be scanned, copied or duplicated, or posted to a publicly accessible website, in whole or part.

Notice that because of symmetry, the components of the field have the same overall magnitude. The force on Sphere A is

$$F_{tot} = \frac{kq^2}{d^2} \left(\frac{2}{\sqrt{2}} \hat{i} + \frac{1}{\sqrt{2}} \hat{j} \right) + \frac{kq^2}{(0.500 \text{ m})^2} \left(\frac{2}{\sqrt{2}} \hat{i} + \frac{1}{\sqrt{2}} \hat{j} \right)$$

$$F_{tot} = (-0.273\hat{i} - 0.273\hat{j} - 0.273\hat{k}) \text{ N}$$

76. Higher. The electrostatic force is larger when they are closer, so the friction force, and hence the coefficient of friction, must be larger.

77. Since the sphere is in static equilibrium, the net force on it is zero.

$$F_x = 0: F_E - F_{s,max} = k \frac{q^2}{r^2} - \mu_s F_N = 0$$

$$F_y = 0: F_N - F_g = F_N - mg = 0$$

From the y equation, $F_N = mg$. Insert this into the x equation, and solve for the coefficient of static friction.

$$\mu_s = \frac{kq^2}{mgr^2}$$

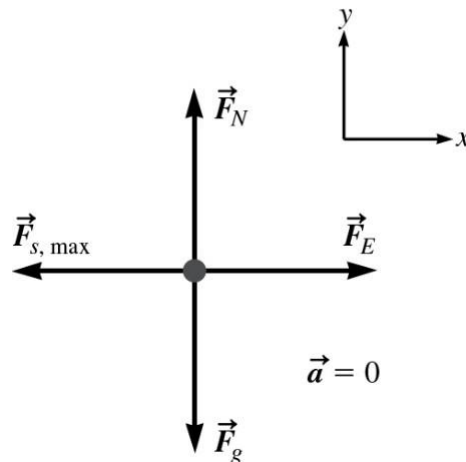

Figure P23.77ANS

78. Applying the equation derived in Problem 77,

$$\mu_s = \frac{kq^2}{mgr^2} = \frac{(8.99 \times 10^9 \text{ N} \cdot \text{m}^2 / \text{C}^2)(89 \times 10^{-9} \text{ C})^2}{(7.5 \times 10^{-5} \text{ kg})(9.81 \text{ m/s}^2)(0.5 \text{ m})^2} = \boxed{0.39}$$

79. At the origin, the net force on q is zero. When displaced a small distance, x , along the x axis, there will be a net force towards the origin—a restoring force. The net force due to the two charges Q is

$$F = F_1 - F_2 = \frac{kQq}{(a+x)^2} - \frac{kQq}{(a-x)^2}$$

This expression is zero for $x = 0$, so we need to expand for small x . We can put this into a form to use the approximation,

$$\frac{1}{1 \pm \delta} \approx 1 \mp 2\delta$$

$$F_x = \frac{kQq}{a^2} \left[\frac{1}{1 + \frac{x}{a}} - \frac{1}{1 - \frac{x}{a}} \right] \approx \frac{kQq}{a^2} \left[\left(1 - 2\frac{x}{a} \right) - \left(1 + 2\frac{x}{a} \right) \right] = -\frac{4kQq}{a^3} x$$

Equivalently, we can find a common denominator,

$$F_x = kQq \frac{(a-x)^2 - (a+x)^2}{(a+x)^2(a-x)^2} = kQq \frac{-4ax}{(a+x)^2(a-x)^2}$$

And then, when $x \ll a$, we can neglect it in the denominator.

$$F_x \approx -\frac{4kQq}{a^3} x$$

This is a linear restoring force with an effective “spring constant” K , that depends on the charges and the separation. By direct analogy with the mass-spring system of Chapter 16, the angular frequency of oscillation of the charge q is given by Equation 16.26.

$$K = \frac{4kQq}{a^3}$$

$$\omega = \sqrt{\frac{k}{ma^3}} = \sqrt{\frac{4kQq}{ma^3}}$$

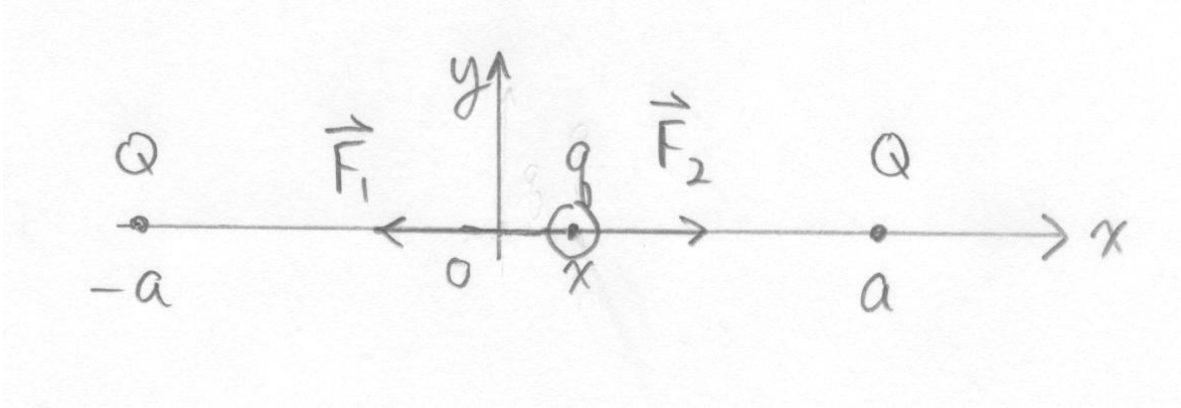

Figure P23.79ANS